

浩德悠然居  
园区标识设计方案

HAODE YOURAN RESIDENCE CONCEPTUAL DESIGN  
SCHEME FOR PARK SIGNAGE

Date 2024/07



08-03024179

陈向向2024-08-03024179

陈向向2024-08-03024179

陈向向2024-08-03024179

陈向向2024-08-03024179

08-03024179

陈向向2024-08-03024179

陈向向2024-08-03024179

陈向向2024-08-03024179

陈向向2024-08-03024179

08-03024179

陈向向2024-08-03024179

陈向向2024-08-03024179

陈向向2024-08-03024179

陈向向2024-08-03024179

08-03024179

陈向向2024-08-03024179

陈向向2024-08-03024179

陈向向2024-08-03024179

陈向向2024-08-03024179



浩德悠然居

## 悠然自得

“自不参其神契，略不与交通，是以浮华之士咸轻而笑之。  
猛悠然自得，不以屑怀。”

唐代《晋书·苻坚载记·附王猛》

# OVERVIEW

项目概况



## 区位 LOCATION

洛阳市 洛龙区



## 产品 PRODUCT

浩德地产TOP产品系

# ARCHITECTURE

建筑风格



## 現代簡約 東方美學

提取中式建筑细节  
整体为新现代东方，建筑立面为现代简洁，造型富有美感，  
赋予建筑端庄、高雅的大宅气质既保留独特韵味，又符合现代人的审美取向。  
倡导隐逸哲学与人文情怀，以当代设计语素凝练隋唐古韵与崭新情境  
溯源城市生活底色.....

现代主义/中式美学 礼序归家/色调素雅



# LANDSCAPE

景观风格



隱居傅世大宅  
静謐山水造園

结合建筑风格和区域特色文化  
景观打造是现代东方隐居传世之园，现代东方，隐居传世  
禅意山水内涵 诗意镌刻生活

隱居傅世大宅  
靜謐山水造園

悠然居

结合建筑风格和区域特色文化  
进行景观提炼打造现代东方隐居传世之园，  
代东方、简洁、高雅



如何通过标识  
来表达项目的气质

HOW SIGNAGE DESIGN SHOULD BE CREATED

陈向向2024-08-03024179

陈向向2024-08-03024179

陈向向2024-08-03024179

現代簡約

東方美學

隱居传世大宅

隱世雅居

靜謐山水

08-03024179

陈向向2024-08-03024179

陈向向2024-08-03024179

陈向向2024-08-03024179

陈向向2024-08-03024179

08-03024179

08-03024179

08-03024179

08-03024179

08-03024179

Environmental  
Graphic  
Design

# DESIGN TONE

结构调性

## 结构 美学

经典纯粹的卯榫结构  
雕琢细节提升品质及格调

我们提取  
建筑及门庭  
传统飞檐的榫卯结构  
通过打散与重组  
古为今用以艺术化的  
构成手法  
赋予标识新的生命

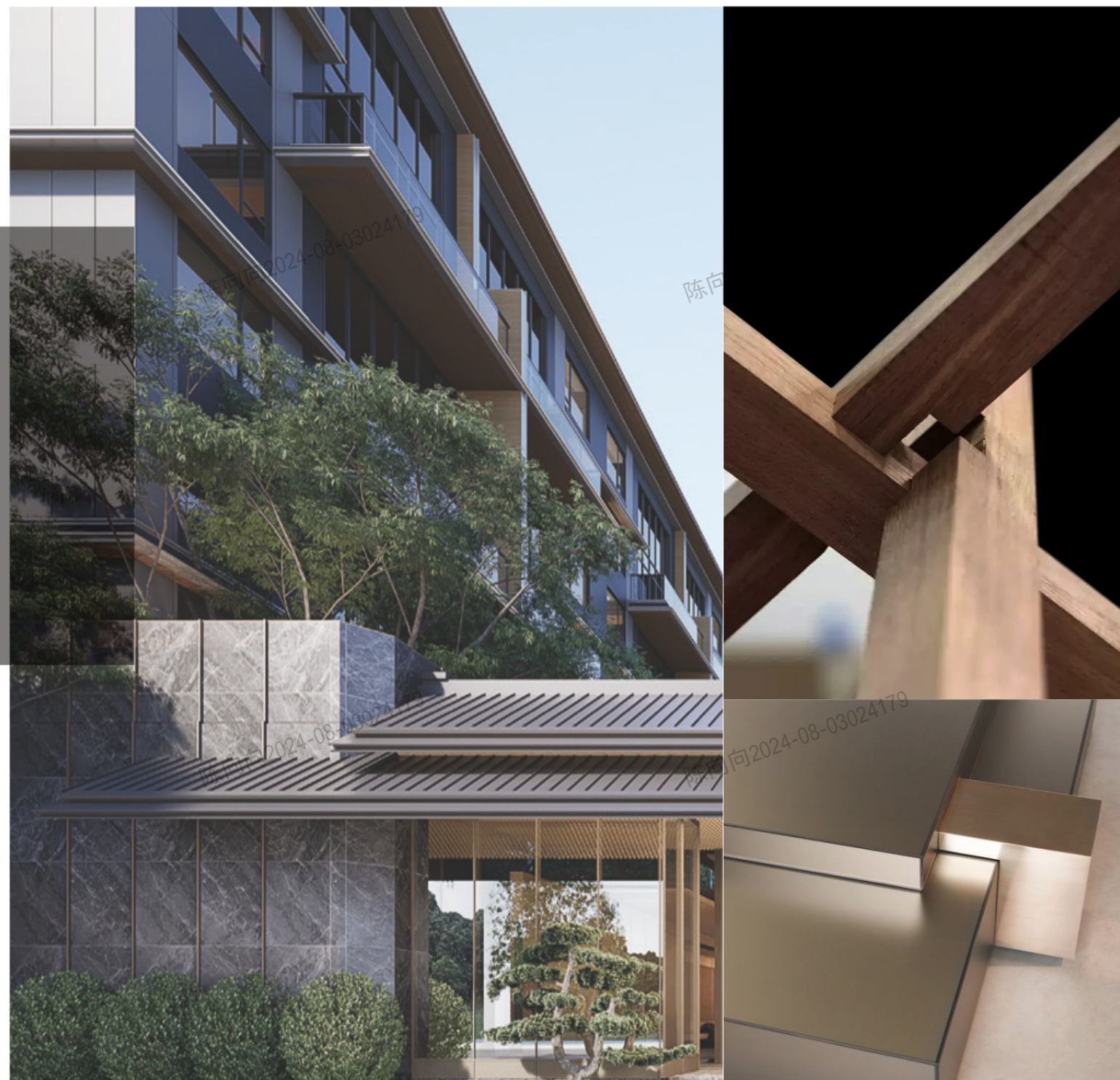

Environmental  
Graphic  
Design

# DESIGN TONE

精奢调性

## 精奢 美学

精致与优雅的材质呈现  
精选具有匠心独运的材质表现

采用三维  
金属字精雕的工匠手法，  
对话与建筑的飞檐，  
同时既融入环境又彰显  
匠心独运的工艺效果，  
此精细呈现无不体现了悠然居的  
精工细作，  
同时又赋予一种沉稳不失  
高贵的气质  
东方美学的内敛与宁静。



Environmental  
Graphic  
Design

# DESIGN TONE

格调调性

## 格调 美学

黑的深邃 金的奢华  
极致臻奢美感  
用精致的做旧金属  
传达项目高端定制奢华的品质

自然元素  
将奢华和精工藏于细节之处  
诗意栖居  
天地间 和谐宁静共悠然

自然的材质与低奢的融合



Environmental  
Graphic  
Design

# DESIGN TONE

标识设计

标识系统

追求隐奢的自然之美

以大道至简

发现本来的生活状态最高级的生活境界

大道至简 大道无形 大道无法

只有心情平静的人

方能视见“斜阳照墟落，穷巷牛羊归”的悠闲，

听闻“荷风送秋气，竹露滴清响”的天籁

标识上同样追求“自然”的设计手法

卯榫的结构,精奢的工艺,低饱和的色彩搭配

传达东方的内敛与宁静

赋予一种沉稳不失高贵的气质

活出悠然的生活状态



1 8  
| |  
5 13  
栋 栋



龙 谧 浣  
宝 云 纱  
乐 筑 颂  
园 台 歌

悠然居





08-03024179

陈向向2024-08-03024179

陈向向2024-08-03024179

陈向向2024-08-03024179

陈向向2024-08-03024179

08-03024179

陈向向2024-08-03024179

陈向向2024-08-03024179

陈向向2024-08-03024179

陈向向2024-08-03024179

08-03024179

陈向向2024-08-03024179

陈向向2024-08-03024179

陈向向2024-08-03024179

陈向向2024-08-03024179

08-03024179

08-03024179

08-03024179

08-03024179

08-03024179

# 3.0

## IMAGE SIGN

陈向向2024-08-03024179  
形象标识

# 3.1.1

## OUTDOOR SIGN PARTS

楼体形象标识

数量:2个

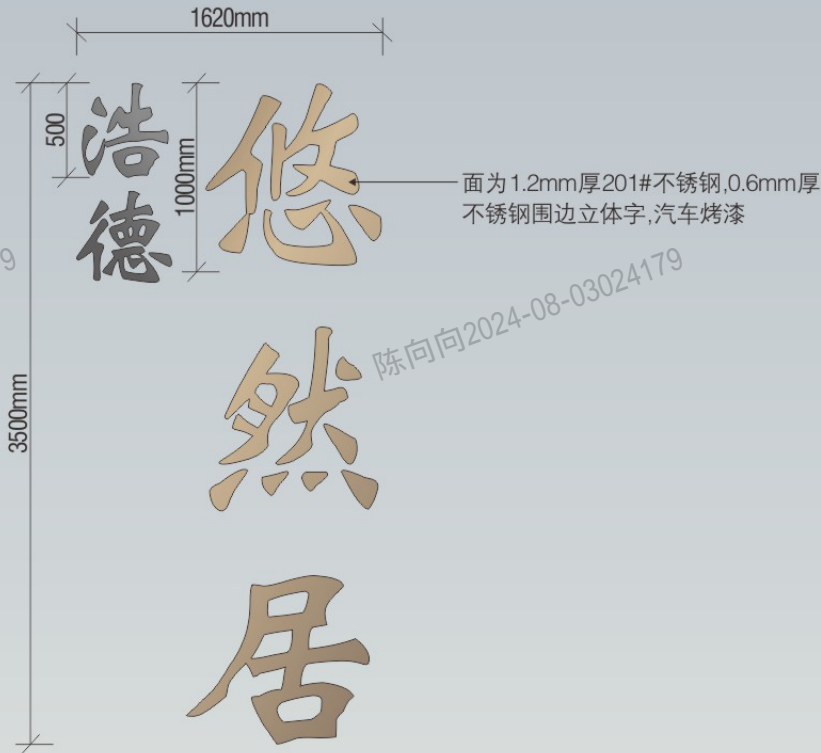

1 正立面 - Front Elevation  
1:10

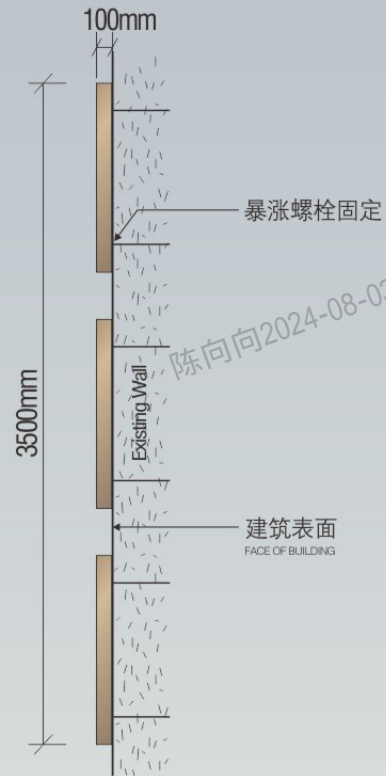

2 侧立面 - Side Elevation  
1:10

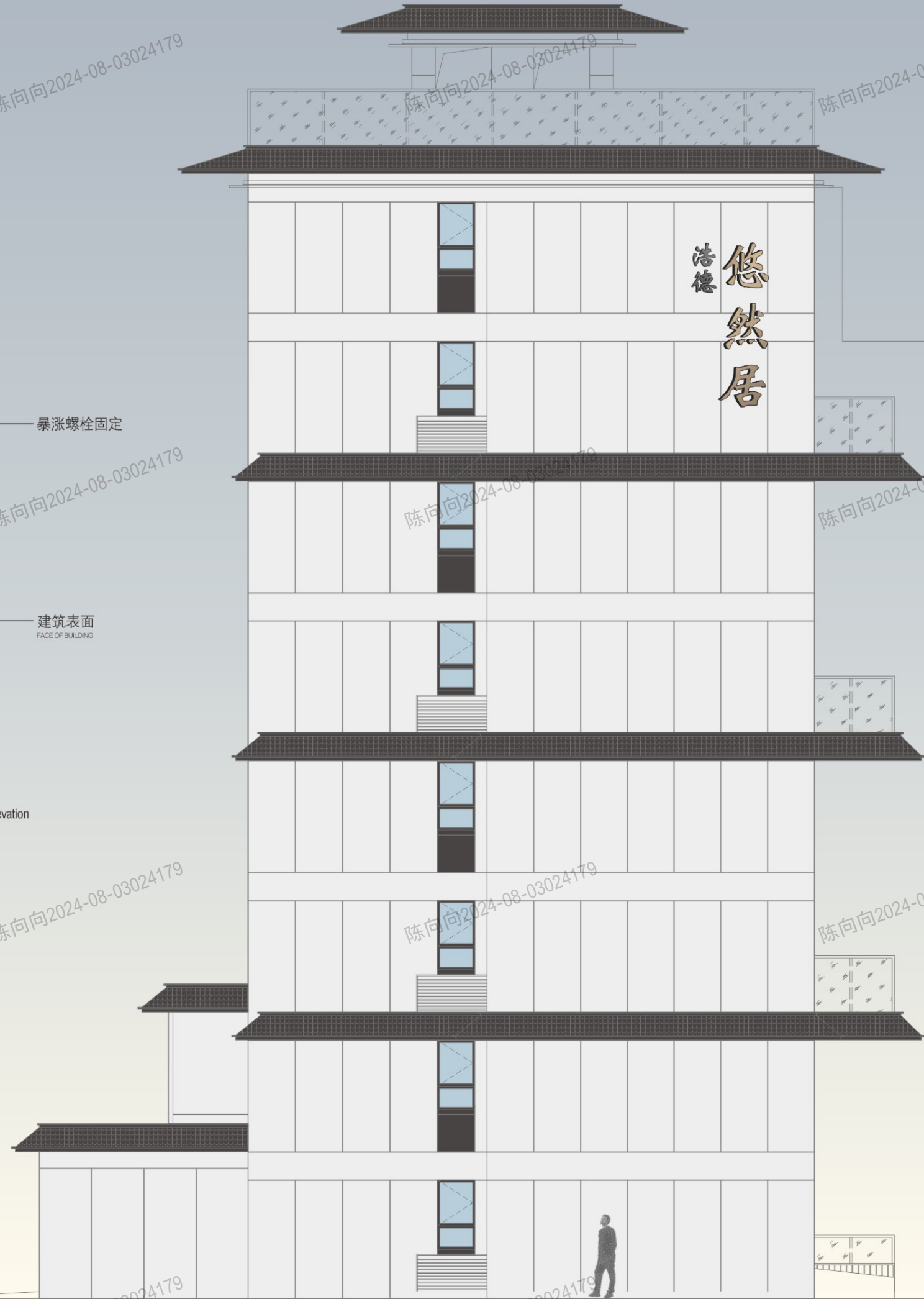

### 备注NOTES:

THE COPYRIGHT OF THIS DRAWING IS OWNED BY HENAN VIENTIANE SIGN DESIGN CO., LTD. 此图版权归河南万象标识设计有限公司所有。DESIGN INTENT ONLY CONTRACTOR TO SUBMIT SHOP DRAWING FOR APPROVAL. 此图仅为施工指导图, 承包商须提交施工详图与有关单位复核。

ALL LOCATION / SETTING OUT TO BE CONFIRMED ON SITE BY CLIENT/DESIGN DESIGN CONSULTANT/CONTRACTOR. 所有标志位置/标志尺寸图须由客户/设计师/项目承包商现场复核确认。

ALL MEASUREMENTS ARE TO BE CONFIRMED ON SITE BY CONTRACTOR. 所有标志尺寸应由项目承包商现场复核确认。

ALL QUANTITY TO BE VERIFIED BY CLIENT/QUANTITY SURVEYOR. 所有标志数量须经客户确认。

CONTRACTOR TO SUBMIT WATERPROOFING DETAIL. 项目承包商负责提交防水细节。

CONTRACTOR RESPONSIBLE FOR STRUCTURAL CALCULATION. 项目承包商应负责有关结构计算。



郑州市金水区北三环73号瀚海北金商务楼B座19A层  
19A floor, block B, Hanhai Beijing business building, 73 North Third Ring Road, Jinshui District, Zhengzhou  
www.hnwxbs.cn

T/F 0371-8606 0306  
18337166686  
13949057575  
18839776686

PROJECT TITLE 项目

CLIENT TITLE 客户

INFORMATION 设计说明

SCALE 图示

APPROVE 审定

CHECK 审核

CHARGE 负责人

DRAWING 制图

DATE 日期

DRAWING NO.

方案一

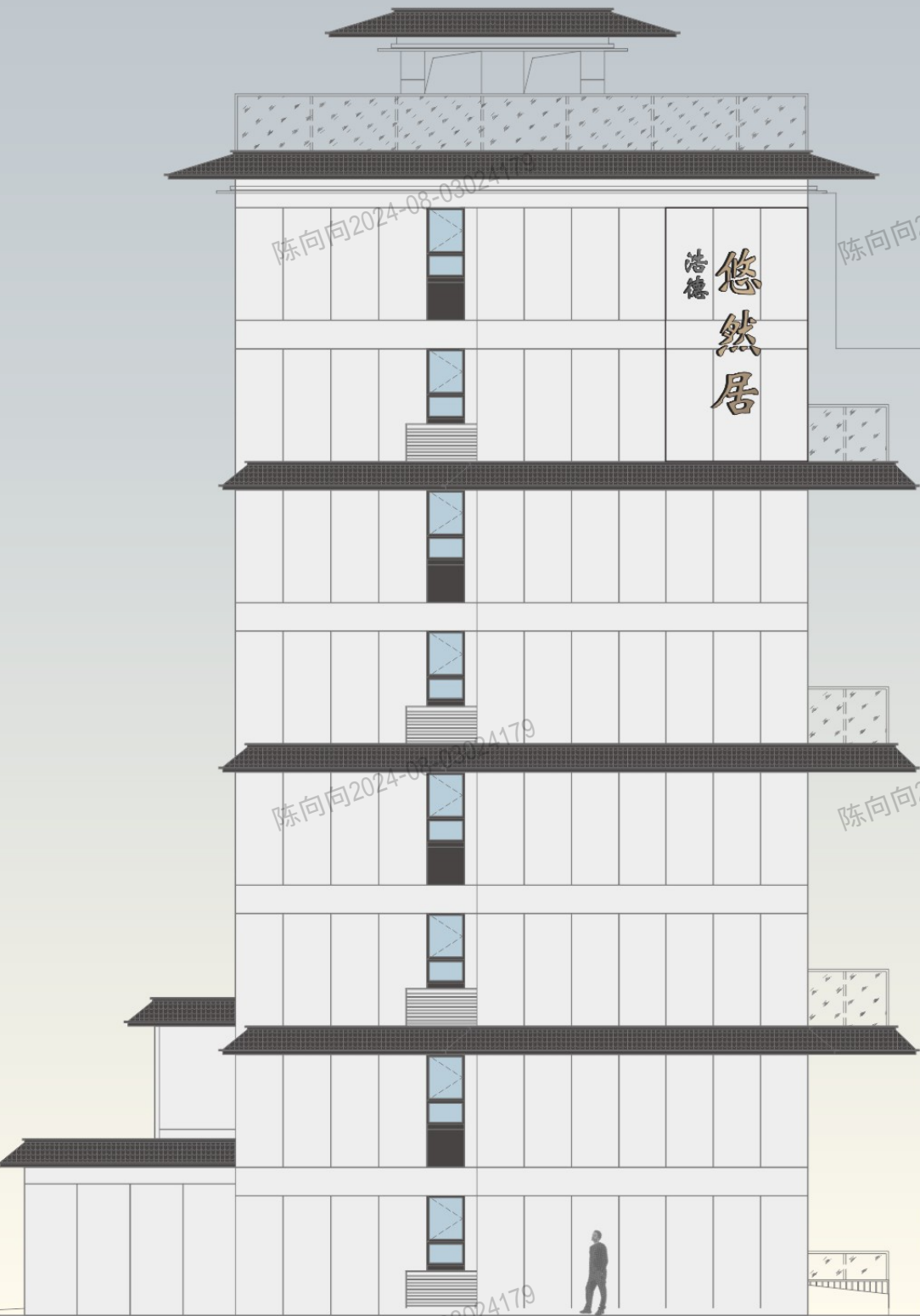

方案二

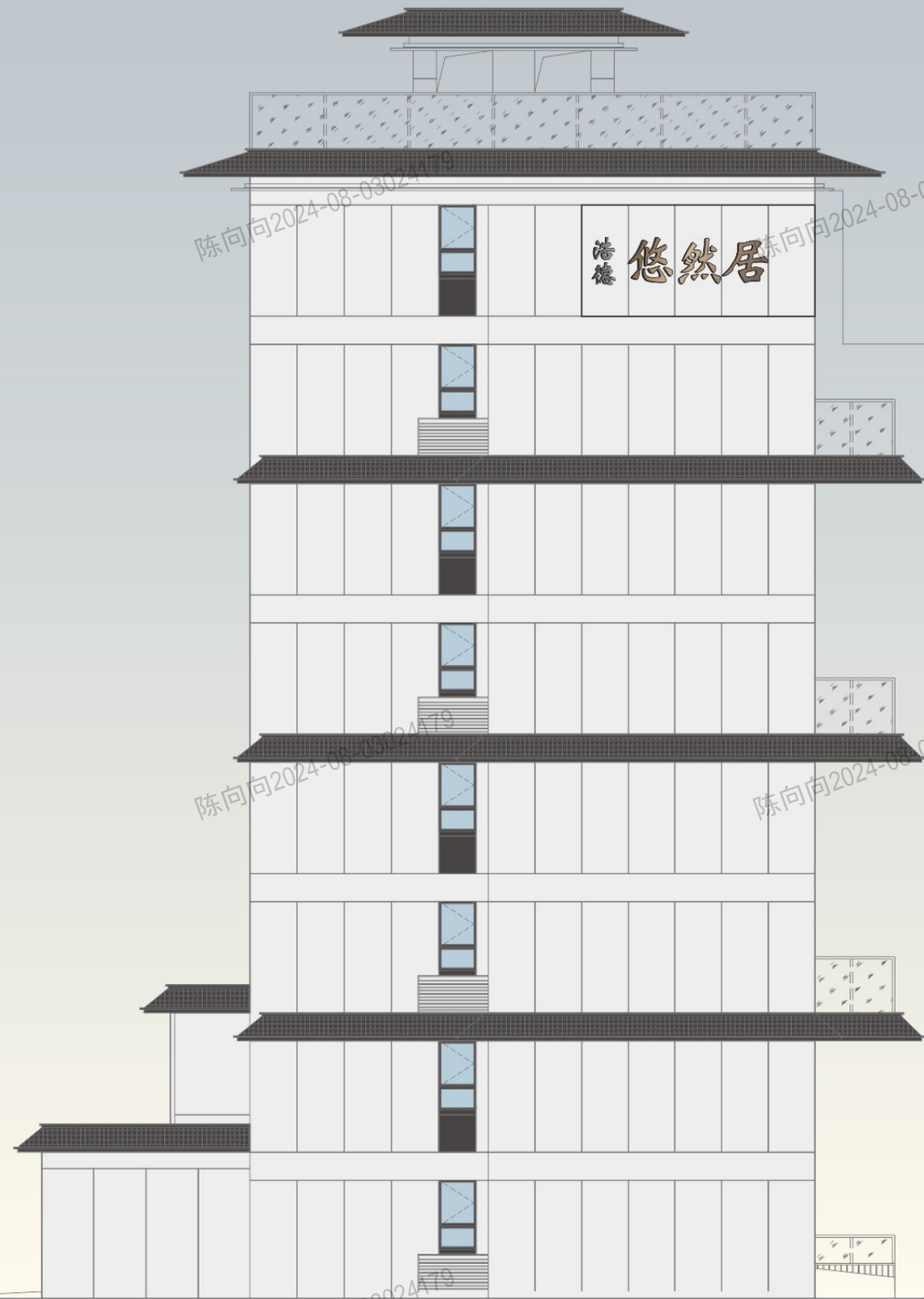

备注NOTES:

THE COPYRIGHT OF THIS DRAWING IS OWNED BY HENAN VIENTIANE SIGN DESIGN CO., LTD. 此图版权归河南万象标识设计有限公司所有。 DESIGN INTENT ONLY CONTRACTOR TO SUBMIT SHOP-DRAWING FOR APPROVAL. 此图仅为施工指导用，承包商须提交施工图并与有关单位核校。

ALL LOCATION / SETTING OUT TO BE CONFIRMED ON SITE BY CLIENT/DESIGN DESIGN CONSULTANT/CONTRACTOR. 所有标志位置/标志尺寸需由客户/设计师/项目承建商现场复核确认。

ALL MEASUREMENTS ARE TO BE CONFIRMED ON SITE BY CONTRACTOR. 所有标志尺寸应由项目承建商现场复核确认。

ALL QUANTITY TO BE VERIFIED BY CLIENT/QUANTITY SURVEYOR. 所有标志数量须经客户确认。

CONTRACTOR TO SUBMIT WATERPROOFING DETAIL. 项目承建商负责提交防水细节。

CONTRACTOR RESPONSIBLE FOR STRUCTURAL CALCULATION. 项目承建商应负责有关结构计算。



郑州市金水区北三环73号瀚海北金商务楼B座19A层  
19A floor, block B, Hanhai Beijing business building, 73 North Third Ring Road, Jinshui District, Zhengzhou  
www.hnwxbs.cn

T/F 0371-8606 0306  
18337166686  
13949057575  
18839776686

PROJECT TITLE 项目

CLIENT TITLE 客户

INFORMATION 设计说明

SCALE 图示

APPROVE 审定

CHECK 审核

CHARGE 负责人

DRAWING 制图

DATE 日期

DRAWING NO.

08-03024179

陈向向2024-08-03024179

陈向向2024-08-03024179

陈向向2024-08-03024179

陈向向2024-08-03024179

08-03024179

陈向向2024-08-03024179

陈向向2024-08-03024179

陈向向2024-08-03024179

陈向向2024-08-03024179

08-03024179

陈向向2024-08-03024179

陈向向2024-08-03024179

陈向向2024-08-03024179

陈向向2024-08-03024179

08-03024179

陈向向2024-08-03024179

陈向向2024-08-03024179

陈向向2024-08-03024179

陈向向2024-08-03024179



08-03024179

陈向向2024-08-03024179

陈向向2024-08-03024179

陈向向2024-08-03024179

陈向向2024-08-03024179

08-03024179

陈向向2024-08-03024179

陈向向2024-08-03024179

陈向向2024-08-03024179

陈向向2024-08-03024179

08-03024179

陈向向2024-08-03024179

陈向向2024-08-03024179

陈向向2024-08-03024179

陈向向2024-08-03024179

08-03024179

陈向向2024-08-03024179

陈向向2024-08-03024179

陈向向2024-08-03024179

陈向向2024-08-03024179



# 3.2.1

## OUTDOOR SIGN PARTS

南侧地库入口标识

数量:1个



示意图-Sketch Map



古铜



### 备注NOTES:

THE COPYRIGHT OF THIS DRAWING IS OWNED BY HENAN VIENTIANE SIGN DESIGN CO., LTD. 此图版权归为河南万象标识设计有限公司所有。 DESIGN INTENT ONLY CONTRACTOR TO SUBMIT SHOP-DRAWING FOR APPROVAL. 此图仅为施工指导图, 承包商须提交施工明细图与有关单位复核。

ALL LOCATION / SETTING OUT TO BE CONFIRMED ON SITE BY CLIENT/DESIGN DESIGN CONSULTANT/CONTRACTOR. 所有标志位置/标志尺寸图须由客户/设计师/项目承包商现场复核确认。

ALL MEASUREMENTS ARE TO BE CONFIRMED ON SITE BY CONTRACTOR. 所有标志尺寸应由项目承包商现场复核确认。

ALL QUANTITY TO BE VERIFIED BY CLIENT/QUANTITY SURVEYOR. 所有标志数量须经客户确认。

CONTRACTOR TO SUBMIT WATERPROOFING DETAIL. 项目承包商负责提交防水细节。

CONTRACTOR RESPONSIBLE FOR STRUCTURAL CALCULATION. 项目承包商应负责有关结构计算。

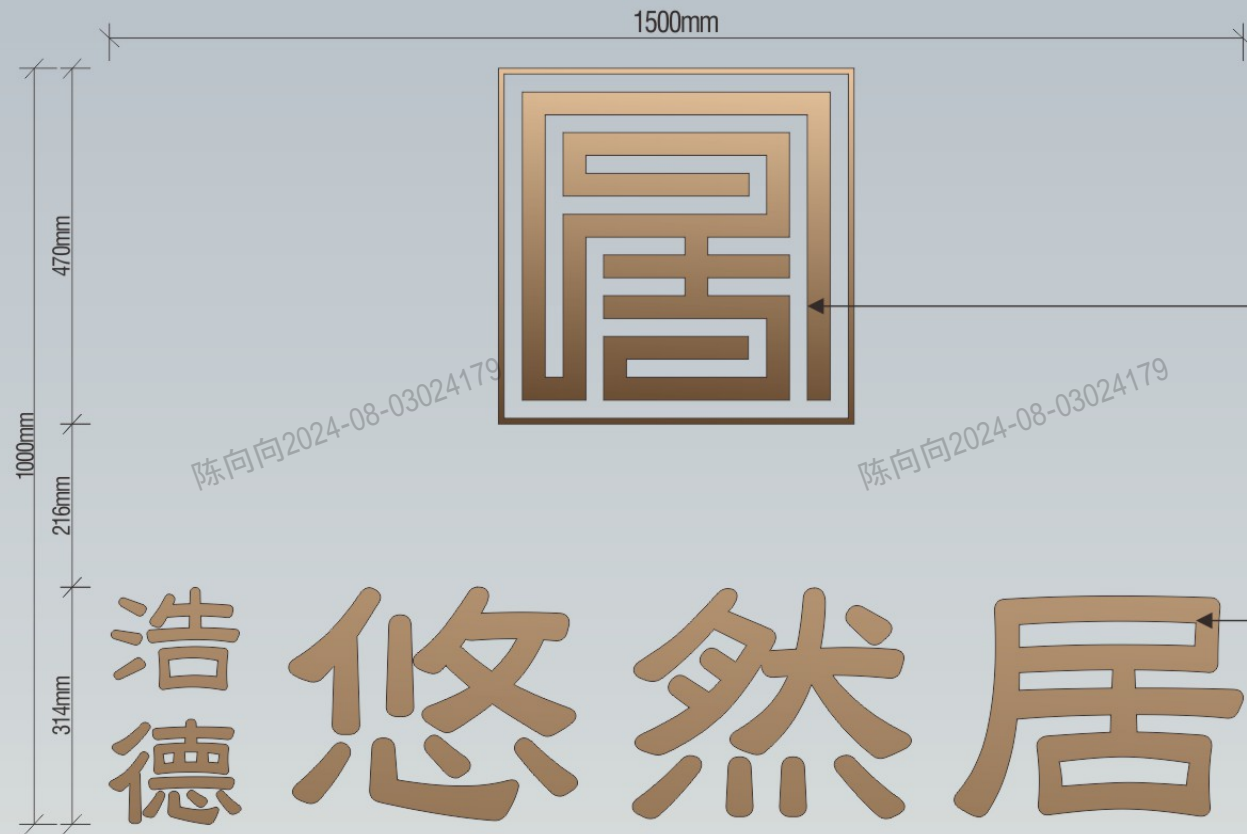

1 正立面-Front Elevation  
1:10

面为1.2mm厚201#不锈钢,0.6mm厚不锈钢围边立体字,侧厚20mm,表面做乱纹古铜效果,背衬10厚mm磨砂亚克力,内置LED防水光源,侧发光

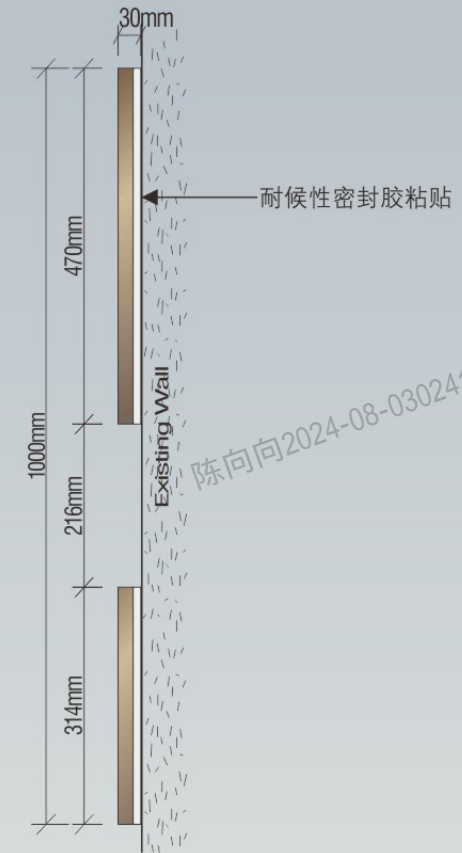

2 侧立面-Side Elevation  
1:10



郑州市金水区北三环73号瀚海北金商务楼B座19A层  
19A floor, block B, Hanhai Beijing business building, 73 North Third Ring Road, Jinshui District, Zhengzhou  
www.hnwxbs.cn

T/F 0371-8606 0306  
18337166686  
13949057575  
18839776686

PROJECT TITLE 项目

CLIENT TITLE 客户

INFORMATION 设计说明

SCALE 图示

APPROVE 审定

CHECK 审核

CHARGE 负责人

DRAWING 制图

DATE 日期

DRAWING NO.



# 3.3.1

## OUTDOOR SIGN PARTS

西侧地库入口标识

数量:1个



示意图-Sketch Map



### 备注NOTES:

THE COPYRIGHT OF THIS DRAWING IS OWNED BY HENAN VIENTIANE SIGN DESIGN CO., LTD. 此图版权归为河南万象标识设计有限公司所有。DESIGN INTENT ONLY CONTRACTOR TO SUBMIT SHOP-DRAWING FOR APPROVAL. 此图仅为施工指导图, 承包商须提交施工明细图与有关单位复核。

ALL LOCATION / SETTING OUT TO BE CONFIRMED ON SITE BY CLIENT/DESIGN DESIGN CONSULTANT/CONTRACTOR. 所有标志位置/标志尺寸图须由客户/设计师/项目承建商现场复核确认。

ALL MEASUREMENTS ARE TO BE CONFIRMED ON SITE BY CONTRACTOR. 所有标志尺寸应由项目承建商现场复核确认。

ALL QUANTITY TO BE VERIFIED BY CLIENT/QUANTITY SURVEYOR. 所有标志数量须经客户确认。

CONTRACTOR TO SUBMIT WATERPROOFING DETAIL. 项目承建商负责提交防水细节。

CONTRACTOR RESPONSIBLE FOR STRUCTURAL CALCULATION. 项目承建商应负责有关结构计算。

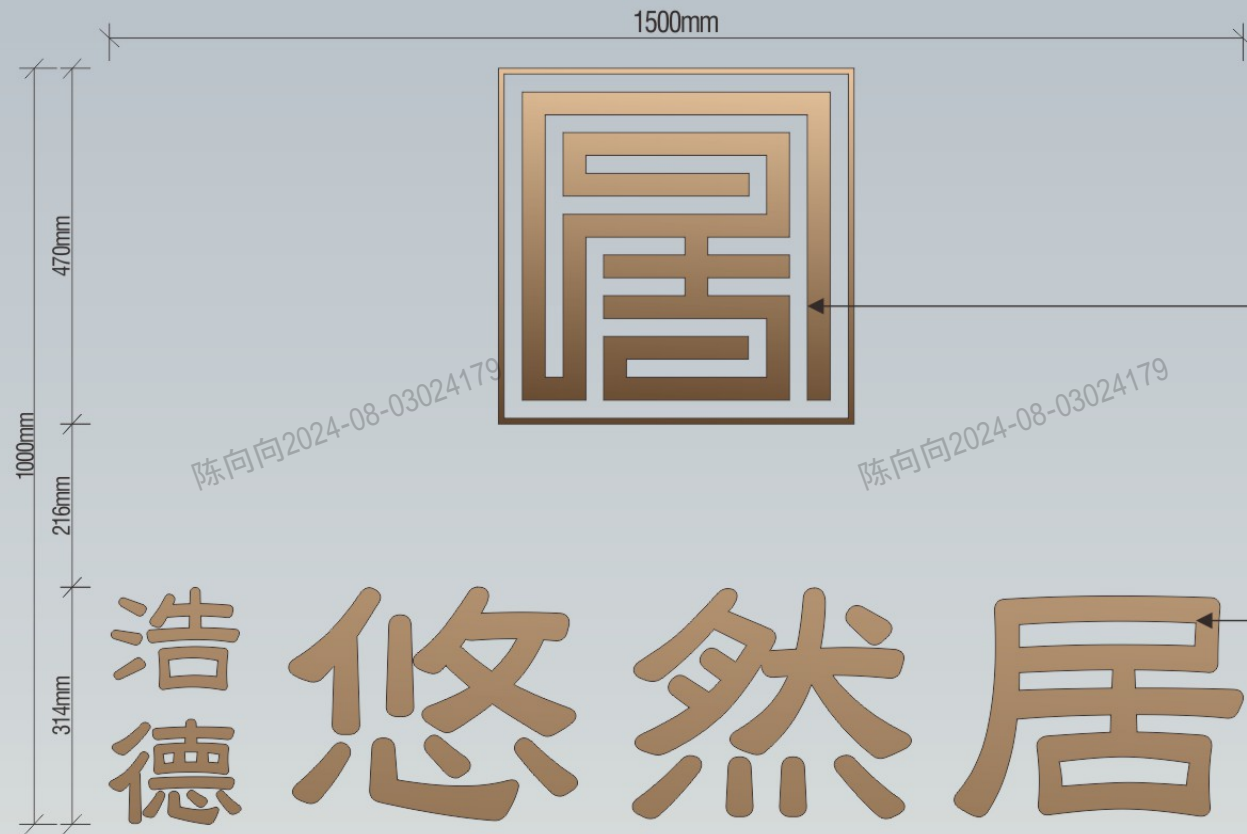

1 正立面-Front Elevation 1:10

面为1.2mm厚201#不锈钢,0.6mm厚不锈钢围边立体字,侧厚20mm,表面做乱纹古铜效果,背衬10厚mm磨砂亚克力,内置LED防水光源,侧发光

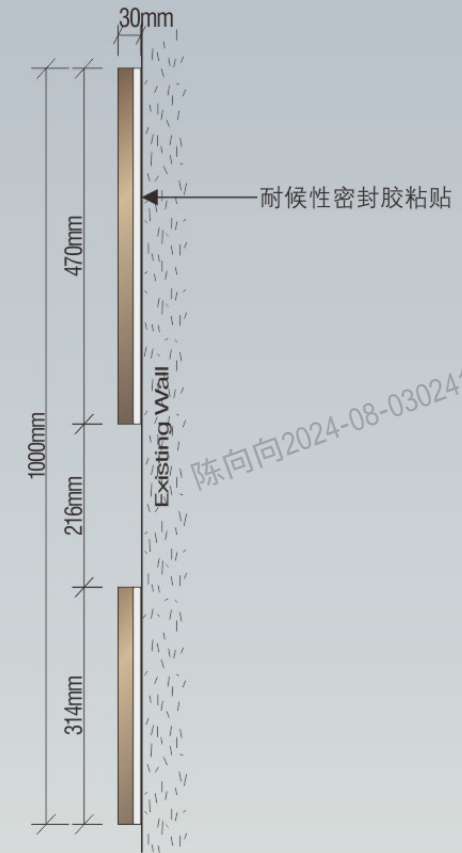

2 侧立面-Side Elevation 1:10



郑州市金水区北三环73号瀚海北金商务楼B座19A层  
19A floor, block B, Hanhai Beijing business building, 73 North Third Ring Road, Jinshui District, Zhengzhou  
www.hnwxbs.cn

T/F 0371-8606 0306  
18337166686  
13949057575  
18839776686

PROJECT TITLE 项目

CLIENT TITLE 客户

INFORMATION 设计说明

SCALE 图示

APPROVE 审定

CHECK 审核

CHARGE 负责人

DRAWING 制图

DATE 日期

DRAWING NO.



# 3.4.1

## OUTDOOR SIGN PARTS

围墙标识

数量:4个

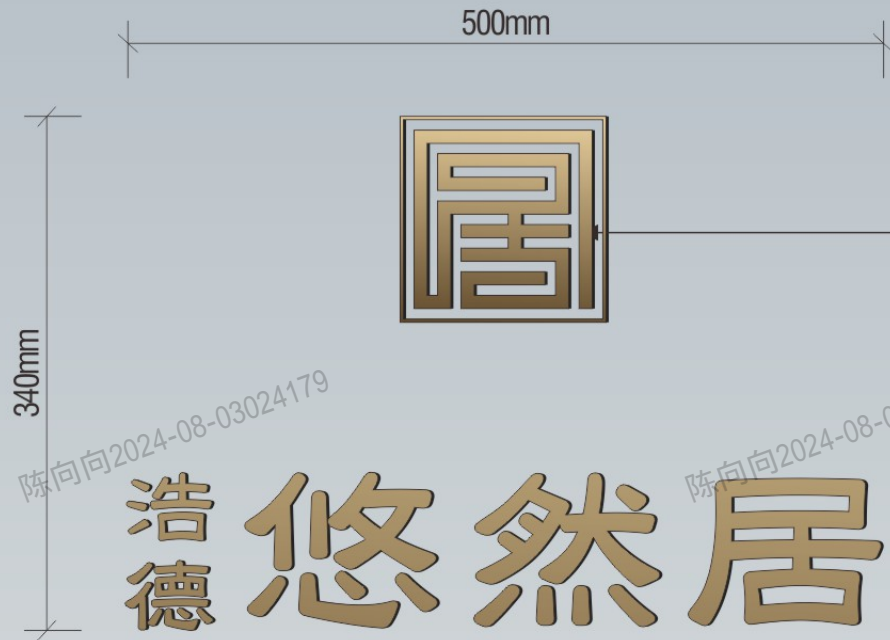

1 正立面 - Front Elevation  
1:5

5mm厚304#不锈钢激光切割成型,  
表面做乱纹古铜效果

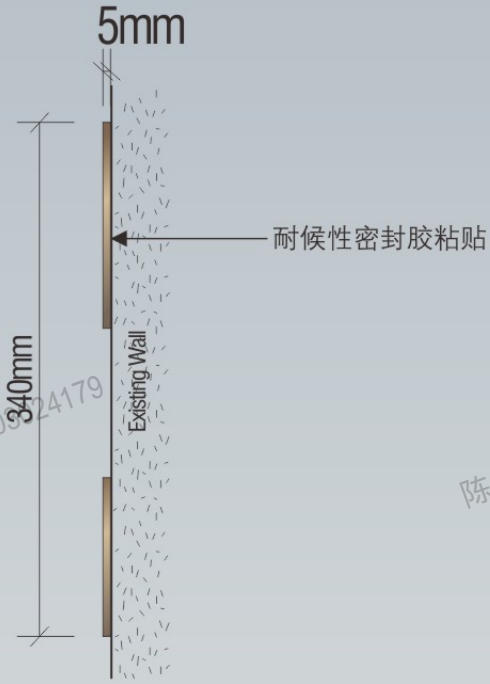

2 侧立面 - Side Elevation  
1:5



### 备注NOTES:

THE COPYRIGHT OF THIS DRAWING IS OWNED BY HENAN VIENTIANE SIGN DESIGN CO., LTD. 此图版权归为河南万象标识设计有限公司所有。DESIGN INTENT ONLY. CONTRACTOR TO SUBMIT SHOP DRAWING FOR APPROVAL. 此图仅为施工指导图, 承包商提交施工明细图与有关单位复核。

ALL LOCATION / SETTING OUT TO BE CONFIRMED ON SITE BY CLIENT/DESIGNER/CONSULTANT/CONTRACTOR. 所有标志位置/标志尺寸由客户/设计师/项目承建商现场复核确认。

ALL MEASUREMENTS ARE TO BE CONFIRMED ON SITE BY CONTRACTOR. 所有标志尺寸应由项目承建商现场复核确认。

ALL QUANTITY TO BE VERIFIED BY CLIENT/QUANTITY SURVEYOR. 所有标志数量须经客户确认。

CONTRACTOR TO SUBMIT WATERPROOFING DETAIL. 项目承建商负责提交防水细节。

CONTRACTOR RESPONSIBLE FOR STRUCTURAL CALCULATION. 项目承建商应负责有关结构计算。



郑州市金水区北三环73号瀚海北金商务楼B座19A层  
19A floor, block B, Hanhai Beijing business building, 73 North Third Ring Road, Jinshui District, Zhengzhou  
www.hnwxbs.cn

T/F 0371-8606 0306  
18337166686  
13949057575  
18839776686

PROJECT TITLE 项目

CLIENT TITLE 客户

INFORMATION 设计说明

SCALE 图示

APPROVE 审定

CHECK 审核

CHARGE 负责人

DRAWING 制图

DATE 日期

DRAWING NO.

# 3.5.1

## OUTDOOR SIGN PARTS

南入口廊架标识  
数量:3套

100mm

心似白云常自在  
意如流水任东西

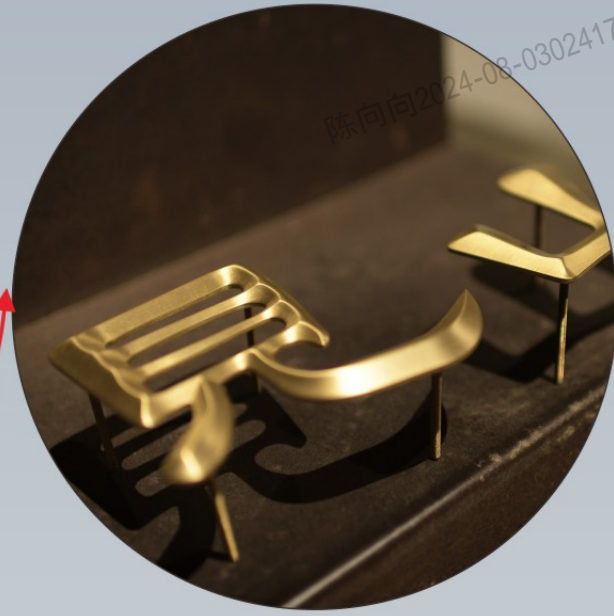

15mm厚乱纹铝板CNC三维雕刻锥形立体字  
表面做乱纹古铜效果



### 备注NOTES:

THE COPYRIGHT OF THIS DRAWING IS OWNED BY HENAN VIENTIANE SIGN DESIGN CO., LTD. 此图版权归河南万象标识设计有限公司所有。DESIGN INTENT ONLY CONTRACTOR TO SUBMIT SHOP-DRAWING FOR APPROVAL. 此图仅为施工指导图, 承包商须提交施工明细图与有关单位复核。

ALL LOCATION / SETTING OUT TO BE CONFIRMED ON SITE BY CLIENT/DESIGN DESIGN CONSULTANT/CONTRACTOR. 所有标志位置/标志尺寸图须由客户/设计师/项目承包商现场复核确认。

ALL MEASUREMENTS ARE TO BE CONFIRMED ON SITE BY CONTRACTOR. 所有标志尺寸应由项目承包商现场复核确认。

ALL QUANTITY TO BE VERIFIED BY CLIENT/QUANTITY SURVEYOR. 所有标志数量须经客户确认。

CONTRACTOR TO SUBMIT WATERPROOFING DETAIL. 项目承包商负责提交防水细节。

CONTRACTOR RESPONSIBLE FOR STRUCTURAL CALCULATION. 项目承包商应负责有关结构计算。



郑州市金水区北三环73号瀚海北金商务楼B座19A层  
19A floor, block B, Hanhai Beijing business building, 73 North Third Ring Road, Jinshui District, Zhengzhou  
www.hnwxbs.cn

T/F 0371-8606 0306  
18337166686  
13949057575  
18839776686

PROJECT TITLE 项目

CLIENT TITLE 客户

INFORMATION 设计说明

SCALE 图示

APPROVE 审定

CHECK 审核

CHARGE 负责人

DRAWING 制图

DATE 日期

DRAWING NO.

# 3.6.1

## OUTDOOR SIGN PARTS

风轻云境标识

数量:1个

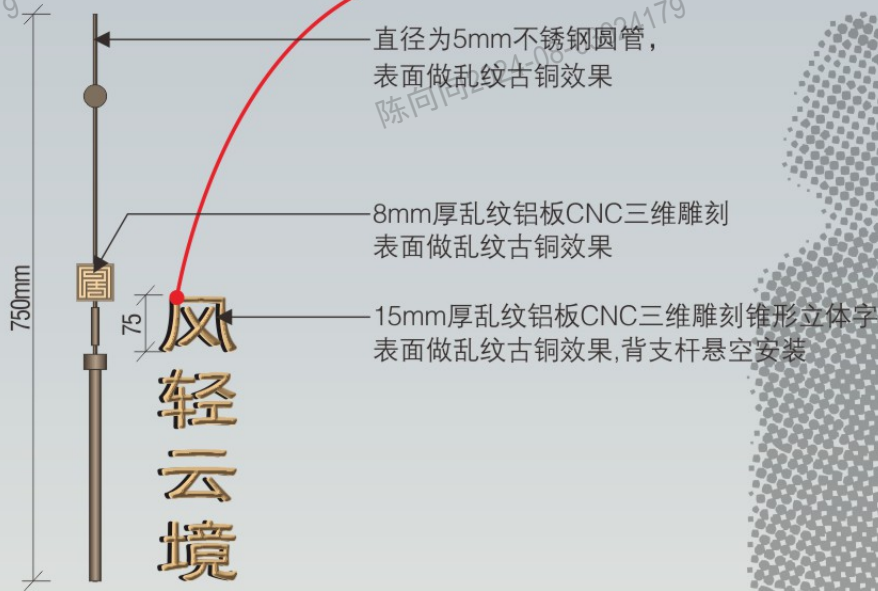
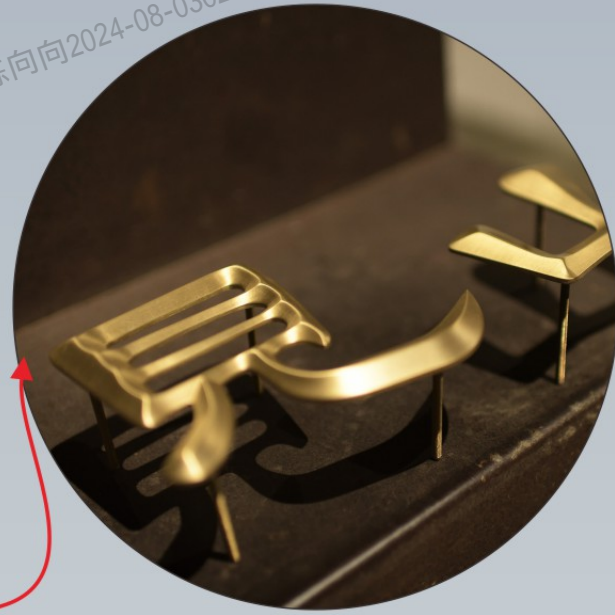

1 正立面-Front Elevation 1:10

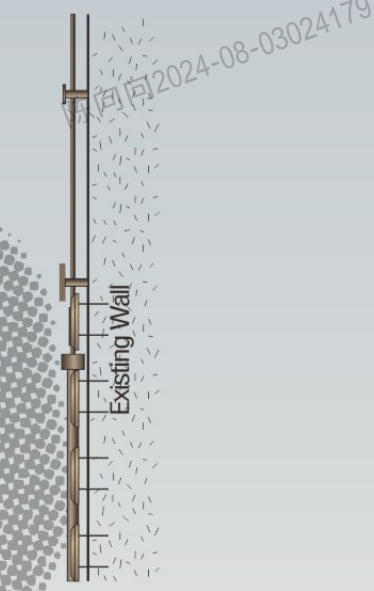

2 侧立面-Side Elevation 1:10



### 备注NOTES:

THE COPYRIGHT OF THIS DRAWING IS OWNED BY HENAN VIENTIANE SIGN DESIGN CO., LTD. 此图版权归为河南万象标识设计有限公司所有。DESIGN INTENT ONLY CONTRACTOR TO SUBMIT SHOP-DRAWING FOR APPROVAL. 此图仅为施工指导图, 承包商须提交施工明细图与有关单位核校。

ALL LOCATION / SETTING OUT TO BE CONFIRMED ON SITE BY CLIENT/DESIGN DESIGN CONSULTANT/CONTRACTOR. 所有标志位置/标志尺寸图须由客户/设计师/项目承包商现场复核确认。

ALL MEASUREMENTS ARE TO BE CONFIRMED ON SITE BY CONTRACTOR. 所有标志尺寸应由项目承包商现场复核确认。

ALL QUANTITY TO BE VERIFIED BY CLIENT/QUANTITY SURVEYOR. 所有标志数量须经客户确认。

CONTRACTOR TO SUBMIT WATERPROOFING DETAIL. 项目承包商负责提交防水细节。

CONTRACTOR RESPONSIBLE FOR STRUCTURAL CALCULATION. 项目承包商应负责有关结构计算。



郑州市金水区北三环73号瀚海北金商务楼B座19A层  
19A floor, block B, Hanhai Beijing business building, 73 North Third Ring Road, Jinshui District, Zhengzhou  
www.hnwxbs.cn

T/F 0371-8606 0306  
18337166686  
13949057575  
18839776686

PROJECT TITLE 项目

CLIENT TITLE 客户

INFORMATION 设计说明

SCALE 图示

APPROVE 审定

CHECK 审核

CHARGE 负责人

DRAWING 制图

DATE 日期

DRAWING NO.

08-03024179

陈向向2024-08-03024179

陈向向2024-08-03024179

陈向向2024-08-03024179

陈向向2024-08-03024179

08-03024179

陈向向2024-08-03024179

陈向向2024-08-03024179

陈向向2024-08-03024179

陈向向2024-08-03024179

08-03024179

陈向向2024-08-03024179

陈向向2024-08-03024179

陈向向2024-08-03024179

陈向向2024-08-03024179

08-03024179

08-03024179

08-03024179

08-03024179

08-03024179

# 4.0

OUTDOOR  
LANDSCAPE SIGN  
景观标识

# 4.1.1

## OUTDOOR SIGN PARTS

平面图标识  
数量:2个

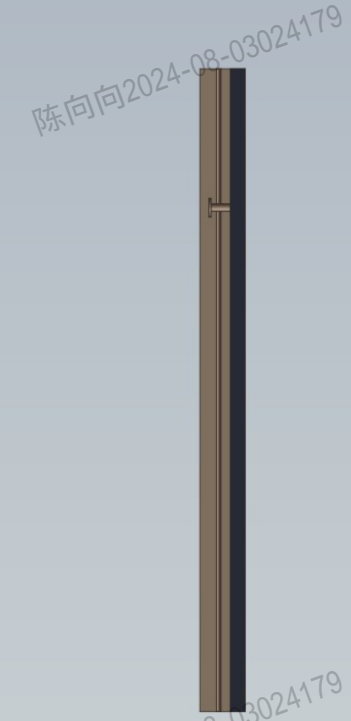
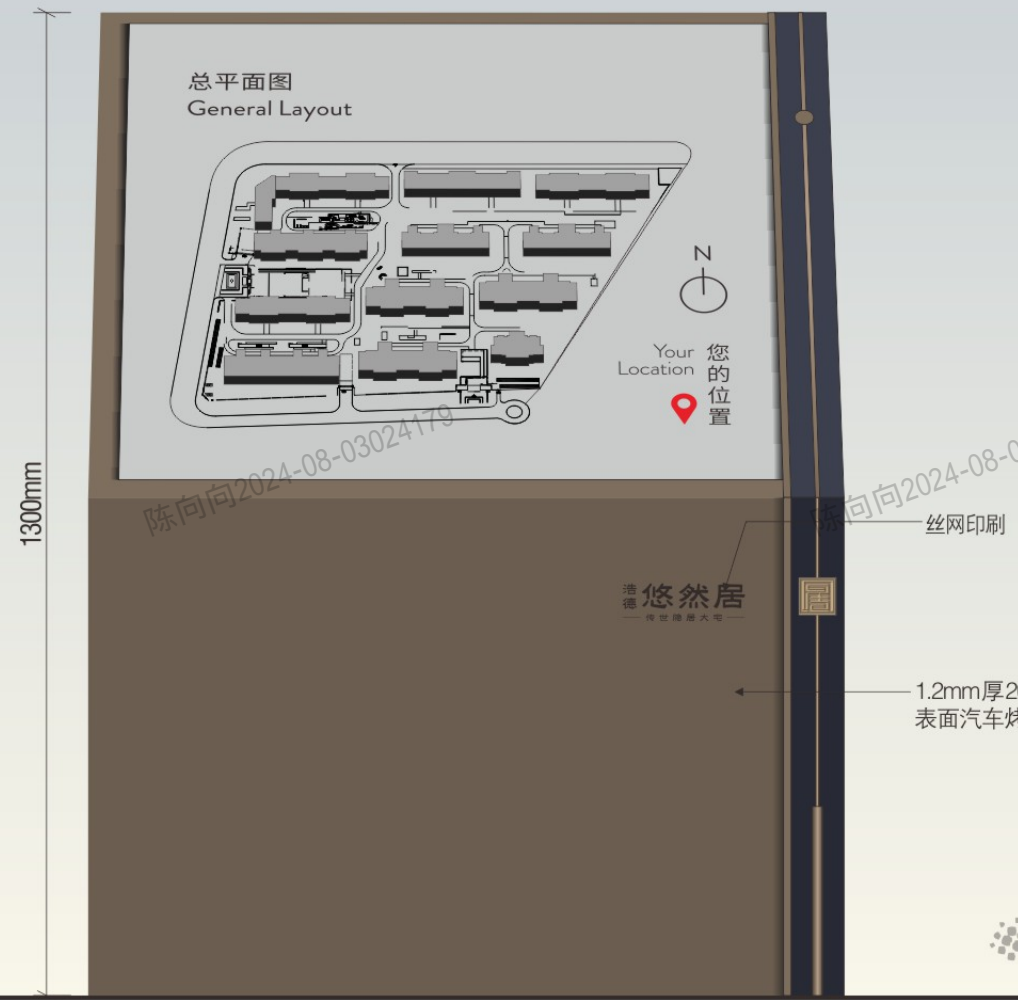
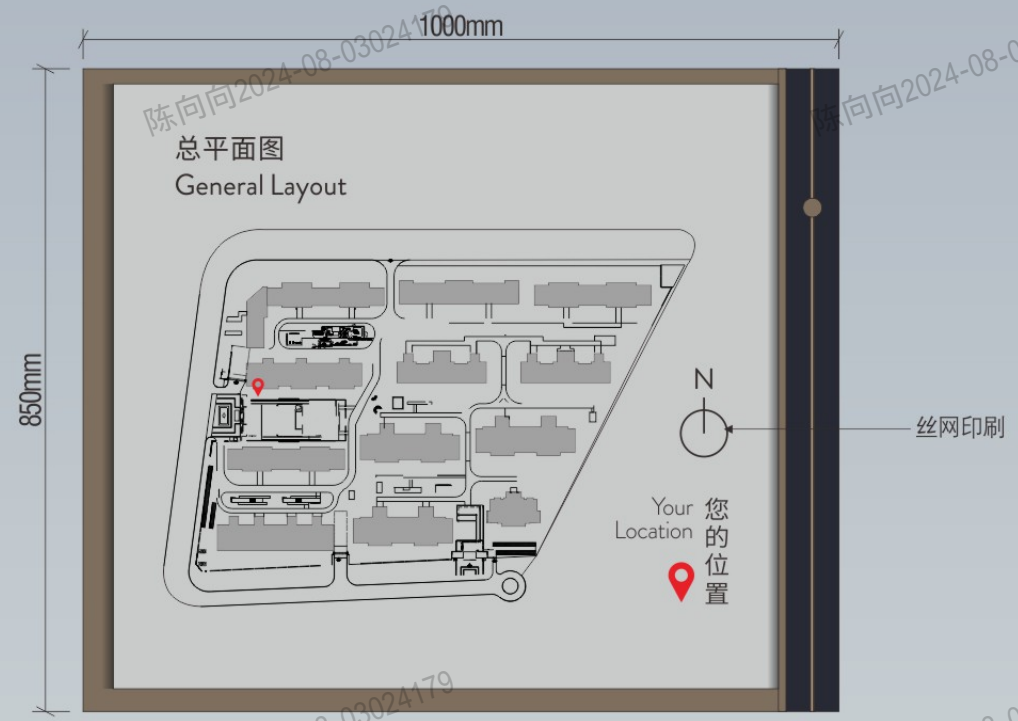

1 正立面-Front Elevation  
1:10

2 侧立面-Side Elevation  
1:10

### 备注NOTES:

THE COPYRIGHT OF THIS DRAWING IS OWNED BY HENAN VIENTIANE SIGN DESIGN CO., LTD. 此图版权归为河南万象标识设计有限公司所有  
DESIGN INTENT ONLY CONTRACTOR TO SUBMIT SHOP-DRAWING FOR APPROVAL  
此图仅为施工指导图, 承包商须提交施工明细图与有关单位复核  
ALL LOCATION / SETTING OUT TO BE CONFIRMED ON SITE BY CLIENT/DESIGN DESIGN CONSULTANT/CONTRACTOR  
所有标志位置/标志尺寸图须由客户/设计师/项目承包商现场复核确认  
ALL MEASUREMENTS ARE TO BE CONFIRMED ON SITE BY CONTRACTOR  
所有标志尺寸应由项目承包商现场复核确认  
ALL QUANTITY TO BE VERIFIED BY CLIENT/QUANTITY SURVEYOR  
所有标志数量须经客户确认  
CONTRACTOR TO SUBMIT WATERPROOFING DETAIL  
项目承包商负责提交防水细节  
CONTRACTOR RESPONSIBLE FOR STRUCTURAL CALCULATION  
项目承包商负责有关结构计算



郑州市金水区北三环73号瀚海北金商务楼B座19A层  
19A floor, block B, Hanhai Beijing business building, 73 North Third Ring Road, Jinshui District, Zhengzhou  
www.hnwxbs.cn  
T/F 0371-8606 0306  
18337166686  
13949057575  
18839776686

### PROJECT TITLE 项目

### CLIENT TITLE 客户

### INFORMATION 设计说明

### SCALE 图示

### APPROVE 审定

### CHECK 审核

### CHARGE 负责人

### DRAWING 制图

### DATE 日期

### DRAWING NO.

# 4.2.1

## OUTDOOR SIGN PARTS

室外宣传栏  
数量:2个



3 顶立面-Top Elevation  
1:10

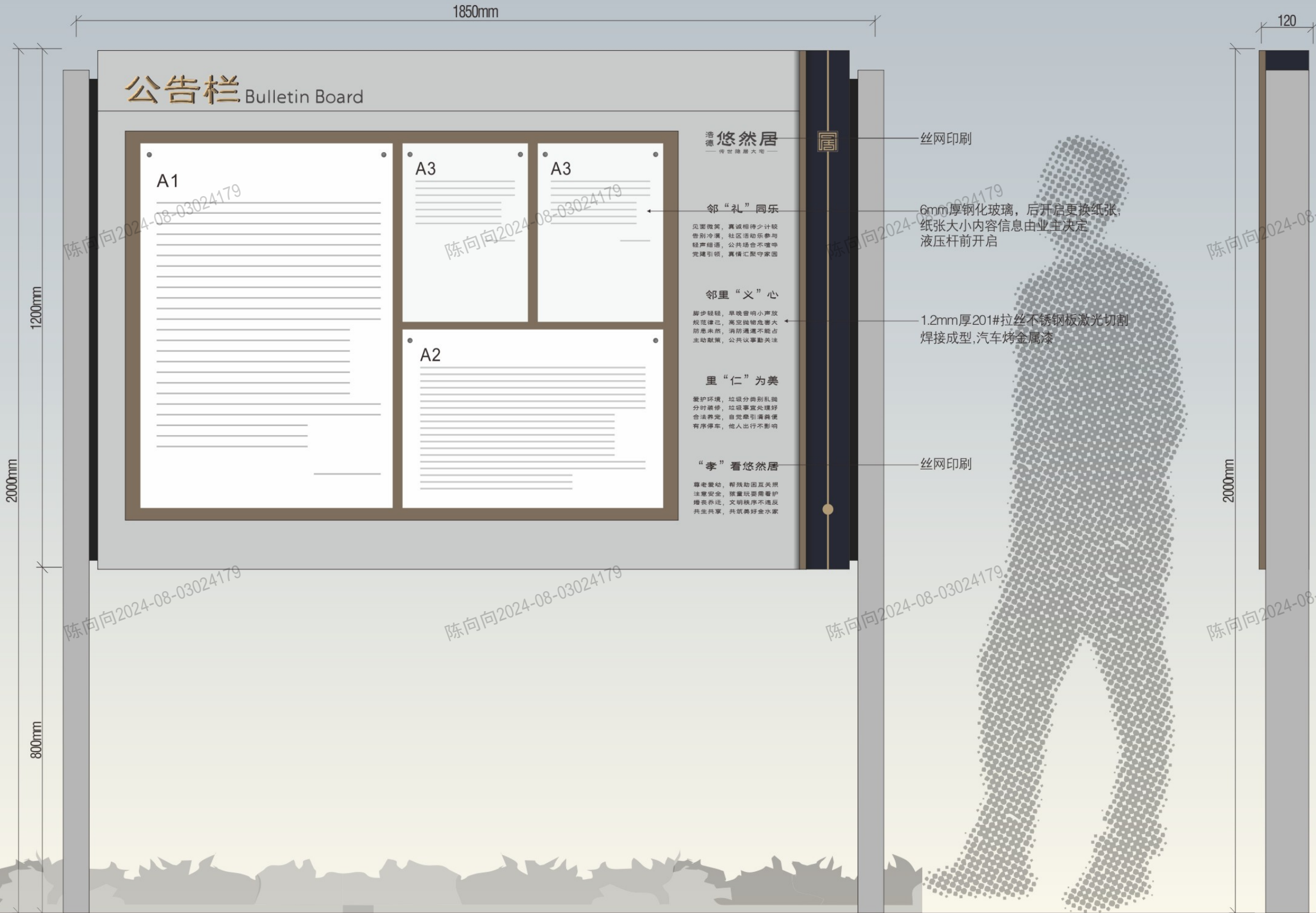

1 正立面-Front Elevation  
1:10

2 侧立面-Side Elevation  
1:10

### 备注NOTES:

THE COPYRIGHT OF THIS DRAWING IS OWNED BY HENAN VIENTIANE SIGN DESIGN CO., LTD. 此图版权归为河南万象标识设计有限公司所有。DESIGN INTENT ONLY CONTRACTOR TO SUBMIT SHOP-DRAWING FOR APPROVAL. 此图仅为施工指导图, 承建商须提交施工明细图与有关单位复核。

ALL LOCATION / SETTING OUT TO BE CONFIRMED ON SITE BY CLIENT/DESIGN DESIGN CONSULTANT/CONTRACTOR. 所有标志位置/标志尺寸图须由客户/设计师/项目承建商现场复核确认。

ALL MEASUREMENTS ARE TO BE CONFIRMED ON SITE BY CONTRACTOR. 所有标志尺寸应由项目承建商现场复核确认。

ALL QUANTITY TO BE VERIFIED BY CLIENT/QUANTITY SURVEYOR. 所有标志数量须经客户确认。

CONTRACTOR TO SUBMIT WATERPROOFING DETAIL. 项目承建商负责提交防水细节。

CONTRACTOR RESPONSIBLE FOR STRUCTURAL CALCULATION. 项目承建商应负责有关结构计算。



郑州市金水区北三环73号瀚海北金商务楼B座19A层  
19A floor, block B, Hanhai Beijing business building, 73 North Third Ring Road, Jinshui District, Zhengzhou  
www.hnwxbs.cn  
T/F 0371-8606 0306  
18337166686  
13949057575  
18839776686

### PROJECT TITLE 项目

### CLIENT TITLE 客户

### INFORMATION 设计说明

### SCALE 图示

### APPROVE 审定

### CHECK 审核

### CHARGE 负责人

### DRAWING 制图

### DATE 日期

### DRAWING NO.

# 4.3.1

## OUTDOOR SIGN PARTS

人行指引标识  
数量:8个



5mm厚铝板三维雕刻, 汽车烤金属漆

1.2mm厚201#不锈钢围激光切割焊接成型, 汽车烤金属漆

1.2mm厚201#不锈钢围激光切割焊接成型, 汽车烤金属漆

丝网印刷

5mm厚铝板三维雕刻, 汽车烤金属漆



### 备注NOTES:

THE COPYRIGHT OF THIS DRAWING IS OWNED BY HENAN VIENTIANE SIGN DESIGN CO., LTD. 此图版权归为河南万象标识设计有限公司所有。DESIGN INTENT ONLY CONTRACTOR TO SUBMIT SHOP DRAWING FOR APPROVAL. 此图仅为施工指导图, 承包商须提交施工明细图与有关单位复核。

ALL LOCATION / SETTING OUT TO BE CONFIRMED ON SITE BY CLIENT/DESIGN DESIGN CONSULTANT/CONTRACTOR. 所有标志位置/标志尺寸图须由客户/设计师/项目承建商现场复核确认。

ALL MEASUREMENTS ARE TO BE CONFIRMED ON SITE BY CONTRACTOR. 所有标志尺寸应由项目承建商现场复核确认。

ALL QUANTITY TO BE VERIFIED BY CLIENT/QUANTITY SURVEYOR. 所有标志数量须经客户确认。

CONTRACTOR TO SUBMIT WATERPROOFING DETAIL. 项目承建商负责提交防水细节。

CONTRACTOR RESPONSIBLE FOR STRUCTURAL CALCULATION. 项目承建商应负责有关结构计算。



郑州市金水区北三环73号瀚海北金商务楼B座19A层  
19A floor, block B, Hanhai Beijing business building, 73 North Third Ring Road, Jinshui District, Zhengzhou  
www.hnwxbs.cn

T/F 0371-8606 0306  
18337166686  
13949057575  
18839776686

PROJECT TITLE 项目

CLIENT TITLE 客户

INFORMATION 设计说明

SCALE 图示

APPROVE 审定

CHECK 审核

CHARGE 负责人

DRAWING 制图

DATE 日期

DRAWING NO.

08-03024179

陈向向2024-08-03024179

陈向向2024-08-03024179

陈向向2024-08-03024179

陈向向2024-08-03024179

08-03024179

陈向向2024-08-03024179

陈向向2024-08-03024179

陈向向2024-08-03024179

陈向向2024-08-03024179

08-03024179

陈向向2024-08-03024179

陈向向2024-08-03024179

陈向向2024-08-03024179

陈向向2024-08-03024179

08-03024179

陈向向2024-08-03024179

陈向向2024-08-03024179

陈向向2024-08-03024179

陈向向2024-08-03024179



08-03024179

陈向向2024-08-03024179

陈向向2024-08-03024179

陈向向2024-08-03024179

08-03024179

陈向向2024-08-03024179

陈向向2024-08-03024179

陈向向2024-08-03024179

08-03024179

陈向向2024-08-03024179

陈向向2024-08-03024179

陈向向2024-08-03024179

08-03024179

08-03024179

08-03024179

08-03024179

08-03024179



08-03024179

陈向向2024-08-03024179

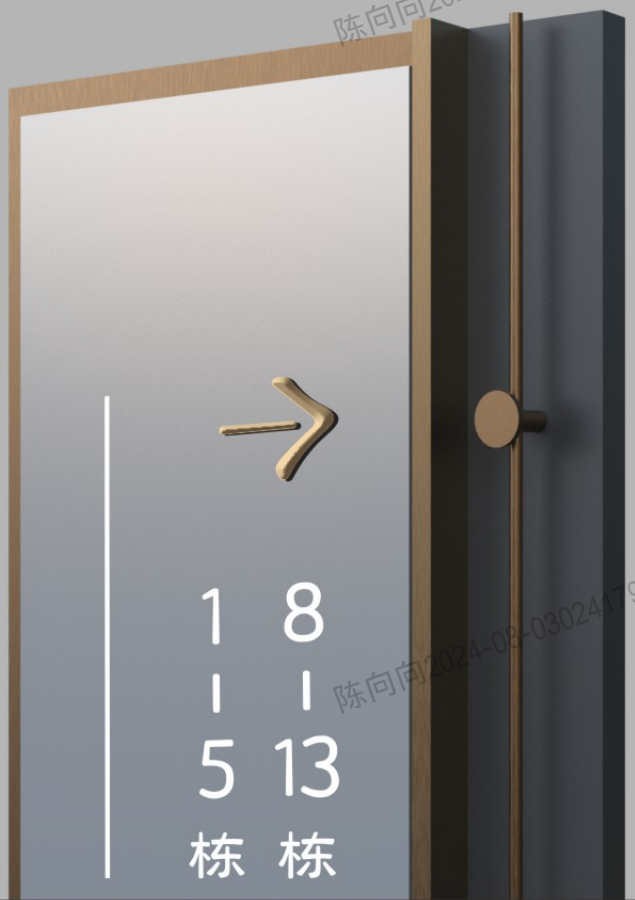

08-03024179

陈向向2024-08-03024179

陈向向2024-08-03024179

陈向向2024-08-03024179

陈向向2024-08-03024179



陈向向2024-08-03024179

陈向向2024-08-03024179

陈向向2024-08-03024179

08-03024179

陈向向2024-08-03024179



陈向向2024-08-03024179

陈向向2024-08-03024179

陈向向2024-08-03024179

08-03024179

陈向向2024-08-03024179

陈向向2024-08-03024179

陈向向2024-08-03024179

陈向向2024-08-03024179

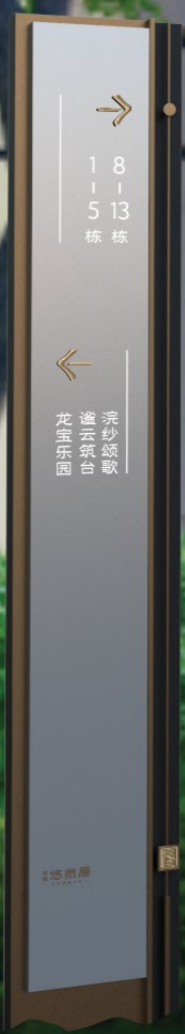

# 4.4.1

## OUTDOOR SIGN PARTS

果皮箱  
数量:14个



4 顶视图-Top Elevation  
1:10

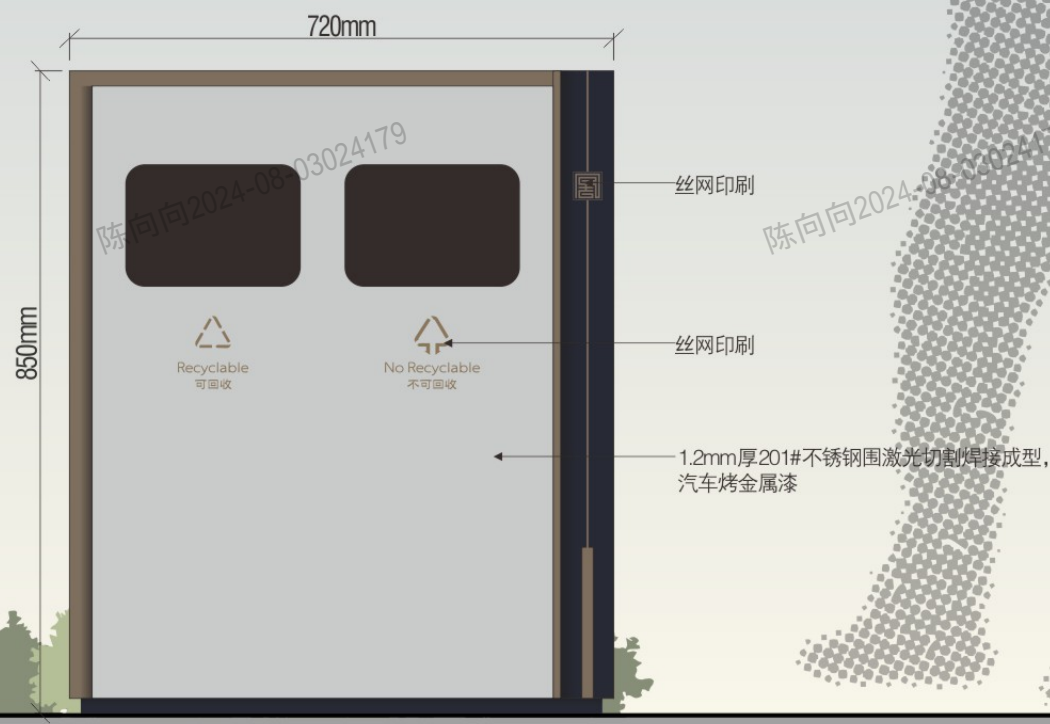

1 立面-Elevation  
1:10

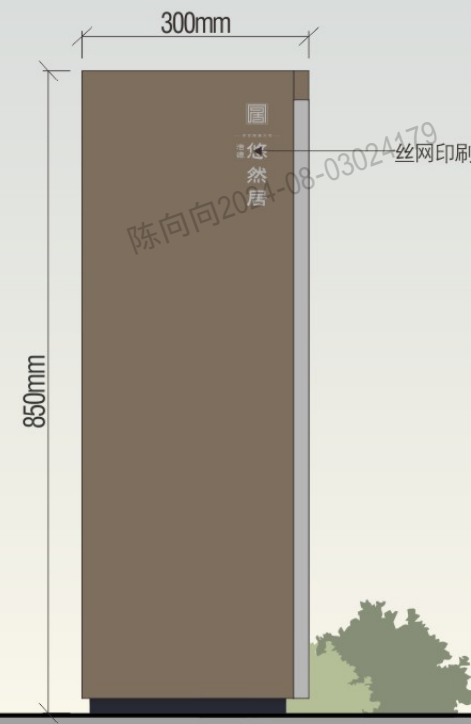

2 侧立面-Side Elevation  
1:10

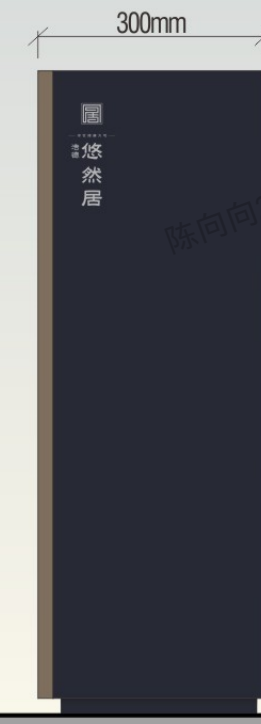

3 侧立面-Side Elevation  
1:10



### 备注NOTES:

THE COPYRIGHT OF THIS DRAWING IS OWNED BY HENAN VIENTIANE SIGN DESIGN CO., LTD. 此图版权归河南万象标识设计有限公司所有。DESIGN INTENT ONLY CONTRACTOR TO SUBMIT SHOP DRAWING FOR APPROVAL. 此图仅为施工指导图, 承包商须提交施工明细图与有关单位复核。  
ALL LOCATION / SETTING OUT TO BE CONFIRMED ON SITE BY CLIENT/DESIGN DESIGN CONSULTANT/CONTRACTOR. 所有标志位置/标志尺寸图须由客户/设计师/项目承包商现场复核确认。  
ALL MEASUREMENTS ARE TO BE CONFIRMED ON SITE BY CONTRACTOR. 所有标志尺寸应由项目承包商现场复核确认。  
ALL QUANTITY TO BE VERIFIED BY CLIENT/QUANTITY SURVEYOR. 所有标志数量须经客户确认。  
CONTRACTOR TO SUBMIT WATERPROOFING DETAIL. 项目承包商负责提交防水细节。  
CONTRACTOR RESPONSIBLE FOR STRUCTURAL CALCULATION. 项目承包商应负责有关结构计算。



郑州市金水区北三环73号瀚海北金商务楼B座19A层  
19A floor, block B, Hanhai Beijin business building, 73 North Third Ring Road, Jinshui District, Zhengzhou  
www.hnwxbs.cn

T/F 0371-8606 0306  
18337166686  
13949057575  
18839776686

### PROJECT TITLE 项目

### CLIENT TITLE 客户

### INFORMATION 设计说明

### SCALE 图示

### APPROVE 审定

### CHECK 审核

### CHARGE 负责人

### DRAWING 制图

### DATE 日期

### DRAWING NO.

# 4.5.1

## OUTDOOR SIGN PARTS

草地温馨提示标识

数量:10个



### 备注NOTES:

THE COPYRIGHT OF THIS DRAWING IS OWNED BY HENAN VIENTIANE SIGN DESIGN CO., LTD. 此图版权归为河南万象标识设计有限公司所有。DESIGN INTENT ONLY CONTRACTOR TO SUBMIT SHOP DRAWING FOR APPROVAL. 此图仅为施工指导图, 承包商须提交施工明细图与有关单位复核。

ALL LOCATION / SETTING OUT TO BE CONFIRMED ON SITE BY CLIENT/DESIGN DESIGN CONSULTANT/CONTRACTOR. 所有标志位置/标志尺寸图须由客户/设计师/项目承建商现场复核确认。

ALL MEASUREMENTS ARE TO BE CONFIRMED ON SITE BY CONTRACTOR. 所有标志尺寸应由项目承建商现场复核确认。

ALL QUANTITY TO BE VERIFIED BY CLIENT/QUANTITY SURVEYOR. 所有标志数量须经客户确认。

CONTRACTOR TO SUBMIT WATERPROOFING DETAIL. 项目承建商负责提交防水细节。

CONTRACTOR RESPONSIBLE FOR STRUCTURAL CALCULATION. 项目承建商应负责有关结构计算。



郑州市金水区北三环73号瀚海北金商务楼B座19A层  
19A floor, block B, Hanhai Beijin business building, 73 North Third Ring Road, Jinshui District, Zhengzhou  
www.hnwxbs.cn

T/F 0371-8606 0306  
18337166686  
13949057575  
18839776686

PROJECT TITLE 项目

CLIENT TITLE 客户

INFORMATION 设计说明

SCALE 图示

APPROVE 审定

CHECK 审核

CHARGE 负责人

DRAWING 制图

DATE 日期

DRAWING NO.

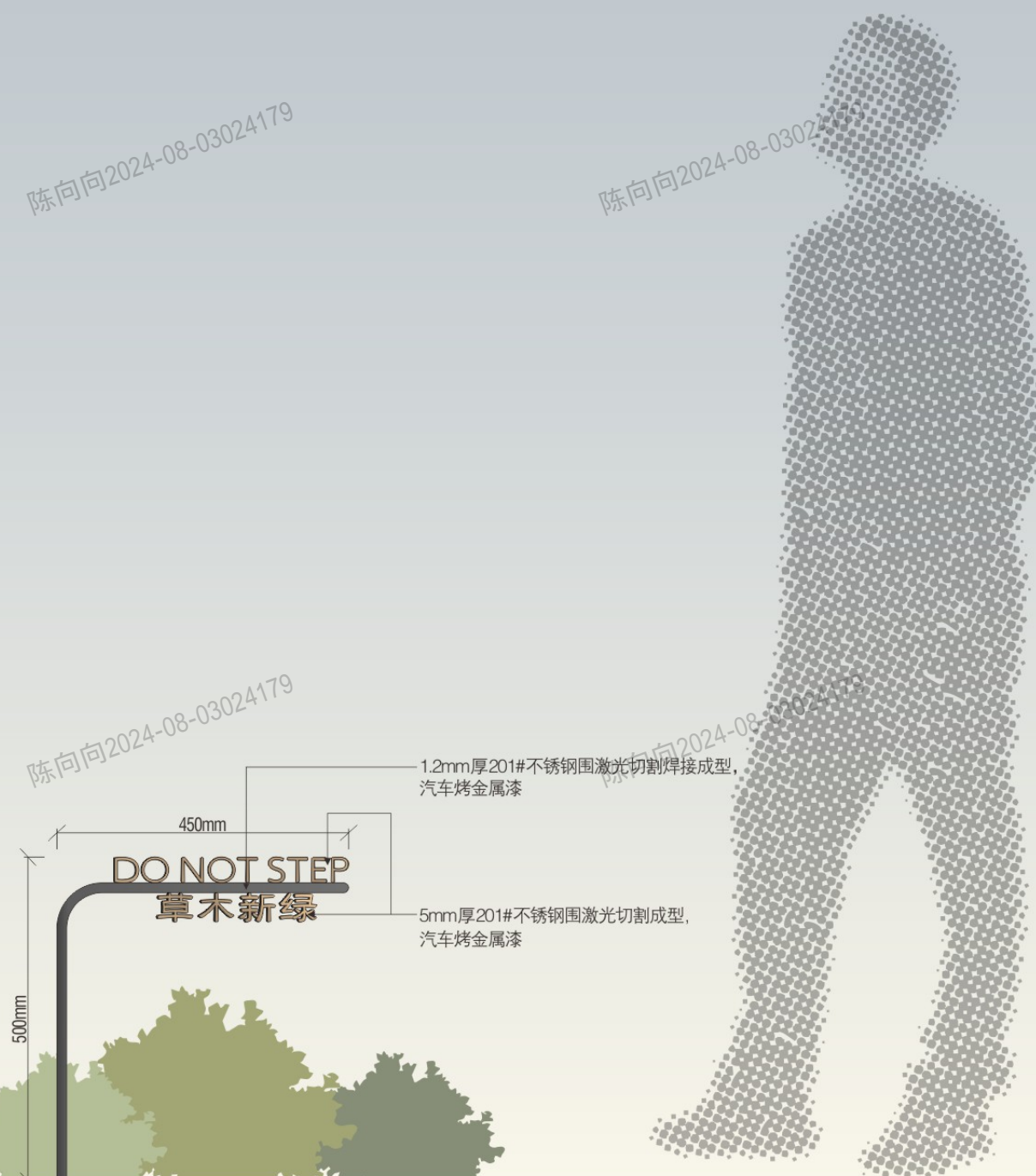

1 正视图-Elevation  
1:10



2 侧立面-Side Elevation  
1:10



DO NOT STEP  
草木新绿

# 4.6.1

## OUTDOOR SIGN PARTS

宠物便箱标识  
数量：2个

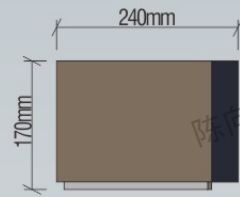

4 顶视图-Top Elevation  
1:10

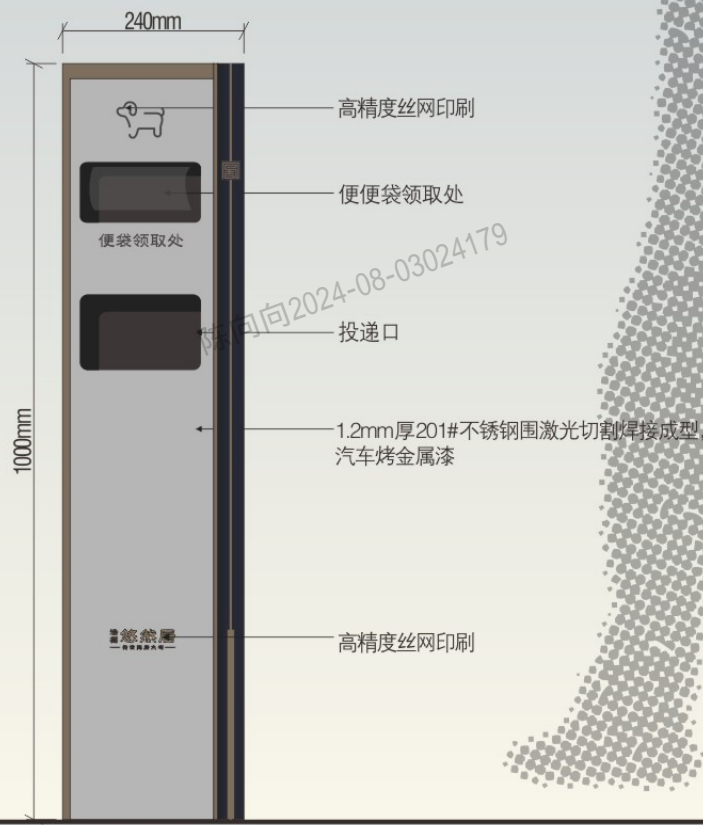

1 正立面-Front Elevation  
1:10

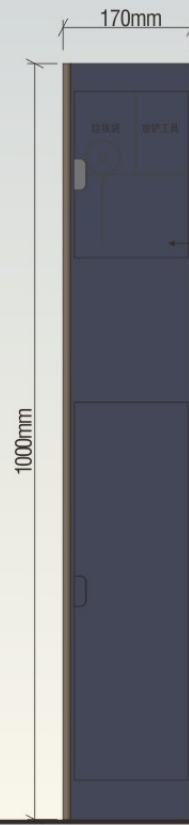
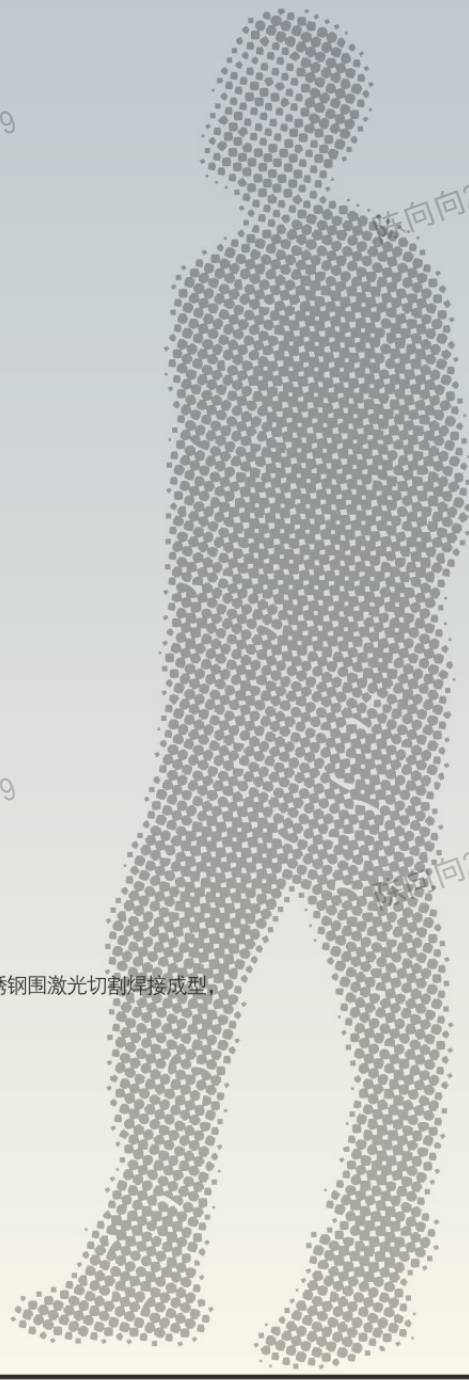

2 右侧立面-Right Side Elevation  
1:10



3 左侧立面-Left Side Elevation  
1:10



### 备注NOTES:

THE COPYRIGHT OF THIS DRAWING IS OWNED BY HENAN VIENTIANE SIGN DESIGN CO., LTD. 此图版权归为河南万象标识设计有限公司所有。DESIGN INTENT ONLY CONTRACTOR TO SUBMIT SHOP DRAWING FOR APPROVAL. 此图仅为施工指导图, 承包商须提交施工明细图与有关单位复核。  
ALL LOCATION / SETTING OUT TO BE CONFIRMED ON SITE BY CLIENT/DESIGN DESIGN CONSULTANT/CONTRACTOR. 所有标志位置/标志尺寸图须由客户/设计师/项目承建商现场复核确认。  
ALL MEASUREMENTS ARE TO BE CONFIRMED ON SITE BY CONTRACTOR. 所有标志尺寸应由项目承建商现场复核确认。  
ALL QUANTITY TO BE VERIFIED BY CLIENT/QUANTITY SURVEYOR. 所有标志数量须经客户确认。  
CONTRACTOR TO SUBMIT WATERPROOFING DETAIL. 项目承建商负责提交防水细节。  
CONTRACTOR RESPONSIBLE FOR STRUCTURAL CALCULATION. 项目承建商应负责有关结构计算。



郑州市金水区北三环73号瀚海北金商务楼B座19A层  
19A floor, block B, Hanhai Beijing business building, 73 North Third Ring Road, Jinshui District, Zhengzhou  
www.hnwxbs.cn  
T/F 0371-8606 0306  
18337166686  
13949057575  
18839776686

PROJECT TITLE 项目

CLIENT TITLE 客户

INFORMATION 设计说明

SCALE 图示

APPROVE 审定

CHECK 审核

CHARGE 负责人

DRAWING 制图

DATE 日期

DRAWING NO.

# 4.7.1

## OUTDOOR SIGN PARTS

树名牌  
数量: 50个

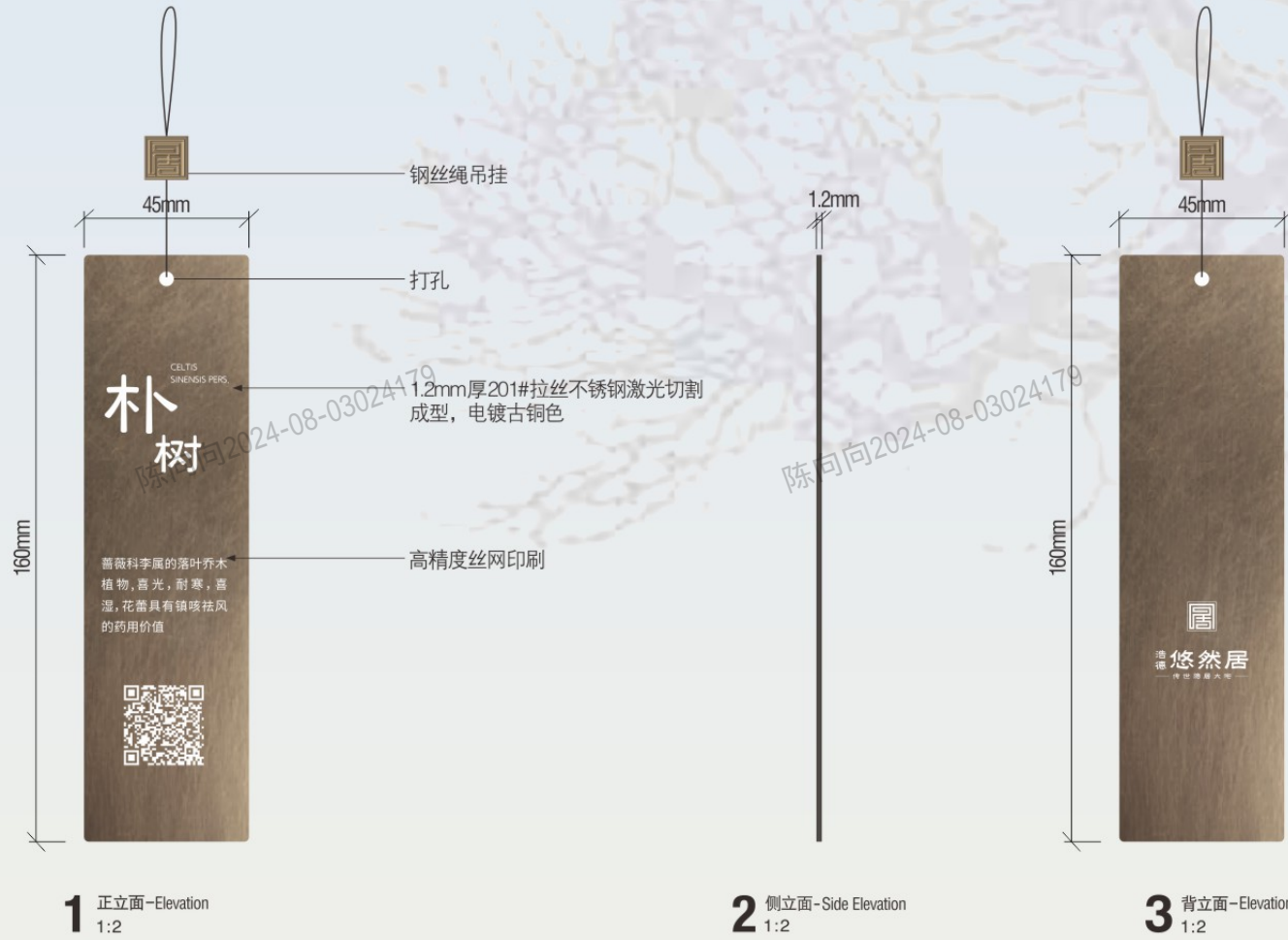

### 备注NOTES:

THE COPYRIGHT OF THIS DRAWING IS OWNED BY HENAN VIENTIANE SIGN DESIGN CO., LTD. 此图版权归河南万象标识设计有限公司所有。DESIGN INTENT ONLY CONTRACTOR TO SUBMIT SHOP-DRAWING FOR APPROVAL. 此图仅为施工指导图, 承包商须提交施工明细图与有关单位复核。

ALL LOCATION / SETTING OUT TO BE CONFIRMED ON SITE BY CLIENT/DESIGN DESIGN CONSULTANT/CONTRACTOR. 所有标志位置/标志尺寸须由客户/设计师/项目承建商现场复核确认。

ALL MEASUREMENTS ARE TO BE CONFIRMED ON SITE BY CONTRACTOR. 所有标志尺寸应由项目承建商现场复核确认。

ALL QUANTITY TO BE VERIFIED BY CLIENT/QUANTITY SURVEYOR. 所有标志数量须经客户确认。

CONTRACTOR TO SUBMIT WATERPROOFING DETAIL. 项目承建商负责提交防水细节。

CONTRACTOR RESPONSIBLE FOR STRUCTURAL CALCULATION. 项目承建商应负责有关结构计算。



郑州市金水区北三环73号瀚海北金商务楼B座19A层  
19A floor, block B, Hanhai Beijing business building, 73 North Third Ring Road, Jinshui District, Zhengzhou  
www.hnwxbs.cn

T/F 0371-8606 0306  
18337166686  
13949057575  
18839776686

### PROJECT TITLE 项目

### CLIENT TITLE 客户

### INFORMATION 设计说明

### SCALE 图示

### APPROVE 审定

### CHECK 审核

### CHARGE 负责人

### DRAWING 制图

### DATE 日期

### DRAWING NO.

# 4.8.1

## OUTDOOR SIGN PARTS

温馨提示类标识  
[小心台阶,请勿攀爬]

数量: 10个



1 立面 - Elevation  
1:2



2 侧立面 - Side Elevation  
1:2

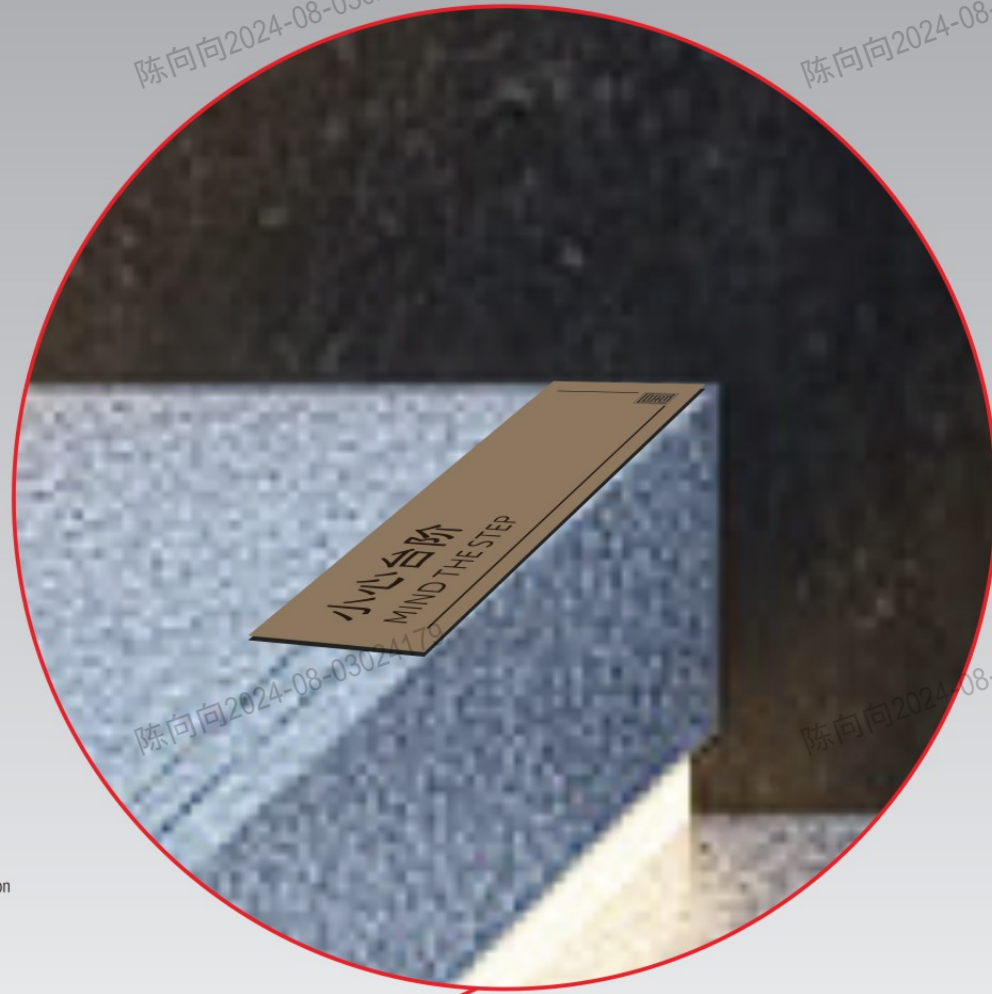

### 备注NOTES:

THE COPYRIGHT OF THIS DRAWING IS OWNED BY HENAN VIENTIANE SIGN DESIGN CO., LTD. 此图版权归为河南万象标识设计有限公司所有。 DESIGN INTENT ONLY CONTRACTOR TO SUBMIT SHOP-DRAWING FOR APPROVAL. 此图仅为施工指导图, 承包商须提交施工明细图与有关单位核校。

ALL LOCATION / SETTING OUT TO BE CONFIRMED ON SITE BY CLIENT/DESIGNER/DESIGN CONSULTANT/CONTRACTOR. 所有标志位置/标志尺寸图须由客户/设计师/项目承建商现场复核确认。

ALL MEASUREMENTS ARE TO BE CONFIRMED ON SITE BY CONTRACTOR. 所有标志尺寸应由项目承建商现场复核确认。

ALL QUANTITY TO BE VERIFIED BY CLIENT/QUANTITY SURVEYOR. 所有标志数量须经客户确认。

CONTRACTOR TO SUBMIT WATERPROOFING DETAIL. 项目承建商负责提交防水细节。

CONTRACTOR RESPONSIBLE FOR STRUCTURAL CALCULATION. 项目承建商应负责有关结构计算。



郑州市金水区北三环73号瀚海北金商务楼B座19A层  
19A floor, block B, Hanhai Beijing business building, 73 North Third Ring Road, Jinshui District, Zhengzhou  
www.hnwxbs.cn

T/F 0371-8606 0306  
18337166686  
13949057575  
18839776686

PROJECT TITLE 项目

CLIENT TITLE 客户

INFORMATION 设计说明

SCALE 图示

APPROVE 审定

CHECK 审核

CHARGE 负责人

DRAWING 制图

DATE 日期

DRAWING NO.

# 4.8.2

## OUTDOOR SIGN PARTS

请勿嬉水标识  
数量: 10个



3mm厚铜板激光切割,做仿古效果



石材铣刻



镶嵌,面与石材齐平

1 正视图-Elevation  
1:10



SKETCH MAP 示意图

### 备注NOTES:

THE COPYRIGHT OF THIS DRAWING IS OWNED BY HENAN VIENTIANE SIGN DESIGN CO., LTD. 此图版权归河南万象标识设计有限公司所有  
DESIGN INTENT ONLY CONTRACTOR TO SUBMIT SHOP DRAWING FOR APPROVAL  
此图仅为施工指导图, 承包商须提交施工明细图与有关单位审核

ALL LOCATION / SETTING OUT TO BE CONFIRMED ON SITE BY CLIENT/DESIGN DESIGN CONSULTANT/CONTRACTOR  
所有标志位置/标志尺寸需由客户/设计师/项目承建商现场复核确认

ALL MEASUREMENTS ARE TO BE CONFIRMED ON SITE BY CONTRACTOR  
所有标志尺寸应由项目承建商现场复核确认

ALL QUANTITY TO BE VERIFIED BY CLIENT/QUANTITY SURVEYOR  
所有标志数量须经客户确认

CONTRACTOR TO SUBMIT WATERPROOFING DETAIL  
项目承建商负责提交防水细节

CONTRACTOR RESPONSIBLE FOR STRUCTURAL CALCULATION  
项目承建商应负责有关结构计算



郑州市金水区北三环73号瀚海北金商务楼B座19A层  
19A floor, block B, Hanhai Beijing business building, 73 North Third Ring Road, Jinshui District, Zhengzhou  
www.hnwxbs.cn

T/F 0371-8606 0306  
18337166686  
13949057575  
18839776686

PROJECT TITLE 项目

CLIENT TITLE 客户

INFORMATION 设计说明

SCALE 图示

APPROVE 审定

CHECK 审核

CHARGE 负责人

DRAWING 制图

DATE 日期

DRAWING NO.

# 4.9.1

## OUTDOOR SIGN PARTS

龙宝乐园安全须知

数量:1个



### 备注NOTES:

THE COPYRIGHT OF THIS DRAWING IS OWNED BY HENAN VIENTIANE SIGN DESIGN CO., LTD. 此图版权归河南万象标识设计有限公司所有。DESIGN INTENT ONLY CONTRACTOR TO SUBMIT SHOP-DRAWING FOR APPROVAL. 此图仅为施工指导用, 承包商须提交施工图并与有关单位核校。

ALL LOCATION / SETTING OUT TO BE CONFIRMED ON SITE BY CLIENT/DESIGN DESIGN CONSULTANT/CONTRACTOR. 所有标志位置/标志尺寸图须由客户/设计师/项目承建商现场复核确认。

ALL MEASUREMENTS ARE TO BE CONFIRMED ON SITE BY CONTRACTOR. 所有标志尺寸应由项目承建商现场复核确认。

ALL QUANTITY TO BE VERIFIED BY CLIENT/QUANTITY SURVEYOR. 所有标志数量须经客户确认。

CONTRACTOR TO SUBMIT WATERPROOFING DETAIL. 项目承建商负责提交防水细节。

CONTRACTOR RESPONSIBLE FOR STRUCTURAL CALCULATION. 项目承建商应负责有关结构计算。



郑州市金水区北三环73号瀚海北金商务楼B座19A层  
19A floor, block B, Hanhai Beijing business building, 73 North Third Ring Road, Jinshui District, Zhengzhou  
www.hnwxbs.cn

T/F 0371-8606 0306  
18337166686  
13949057575  
18839776686

PROJECT TITLE 项目

CLIENT TITLE 客户

INFORMATION 设计说明

SCALE 图示

APPROVE 审定

CHECK 审核

CHARGE 负责人

DRAWING 制图

DATE 日期

DRAWING NO.

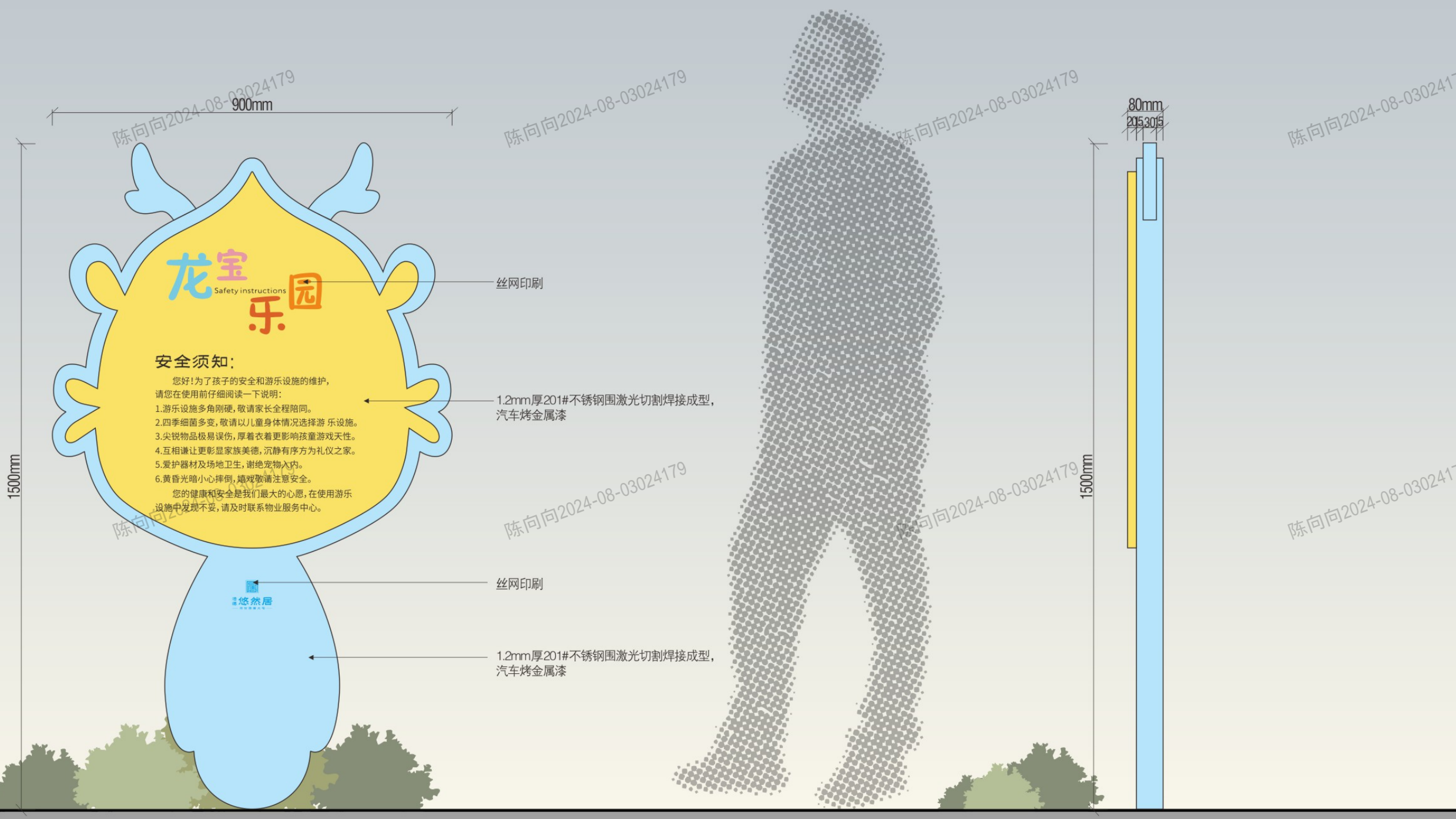

1 立面-Elevation  
1:10

2 侧立面-Side Elevation  
1:10

# 4.10.1

## OUTDOOR SIGN PARTS

健身须知  
数量:2个

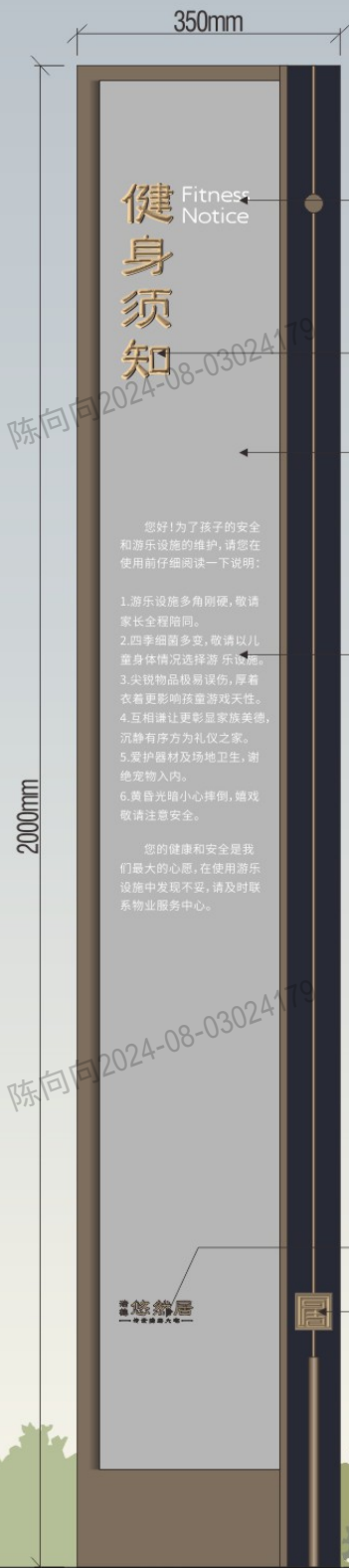

- 丝网印刷
- 5mm厚铝板三维雕刻, 汽车烤金属漆
- 1.2mm厚201#不锈钢围激光切割焊接成型, 汽车烤金属漆
- 丝网印刷
- 丝网印刷
- 5mm厚铝板三维雕刻, 汽车烤金属漆



### 备注NOTES:

THE COPYRIGHT OF THIS DRAWING IS OWNED BY HENAN VIENTIANE SIGN DESIGN CO., LTD. 此图版权归河南万象标识设计有限公司所有。DESIGN INTENT ONLY CONTRACTOR TO SUBMIT SHOP-DRAWING FOR APPROVAL. 此图仅为施工指导图, 承包商提交施工明细图与有关单位核校。

ALL LOCATION / SETTING OUT TO BE CONFIRMED ON SITE BY CLIENT/DESIGN DESIGN CONSULTANT/CONTRACTOR. 所有标志位置/标志尺寸需由客户/设计师/项目承包商现场确认。

ALL MEASUREMENTS ARE TO BE CONFIRMED ON SITE BY CONTRACTOR. 所有标志尺寸应由项目承包商现场确认。

ALL QUANTITY TO BE VERIFIED BY CLIENT/QUANTITY SURVEYOR. 所有标志数量须经客户确认。

CONTRACTOR TO SUBMIT WATERPROOFING DETAIL. 项目承包商负责提交防水细节。

CONTRACTOR RESPONSIBLE FOR STRUCTURAL CALCULATION. 项目承包商应负责有关结构计算。



郑州市金水区北三环73号瀚海北金商务楼B座19A层  
19A floor, block B, Hanhai Beijing business building, 73 North Third Ring Road, Jinshui District, Zhengzhou  
www.hnwxbs.cn

T/F 0371-8606 0306  
18337166686  
13949057575  
18839776686

PROJECT TITLE 项目

CLIENT TITLE 客户

INFORMATION 设计说明

SCALE 图示

APPROVE 审定

CHECK 审核

CHARGE 负责人

DRAWING 制图

DATE 日期

DRAWING NO.

4.11.1

OUTDOOR  
SIGN PARTS

物业服务中心标识  
数量:1个

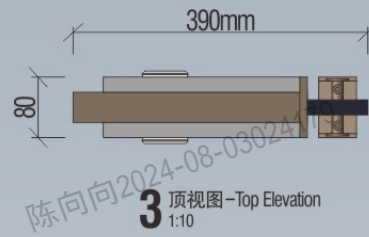

3 顶视图-Top Elevation  
1:10

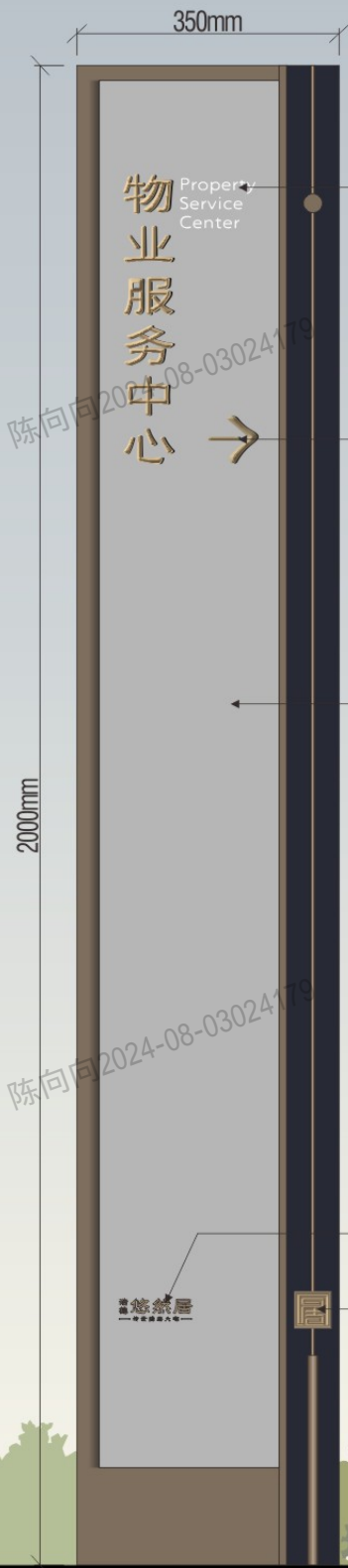

1 立面-Elevation  
1:10



2 侧立面-Side Elevation  
1:10



备注NOTES:

THE COPYRIGHT OF THIS DRAWING IS OWNED BY HENAN VIENTIANE SIGN DESIGN CO., LTD. 此图版权归河南万象标识设计有限公司所有。 DESIGN INTENT ONLY CONTRACTOR TO SUBMIT SHOP DRAWING FOR APPROVAL. 此图仅为施工指导图, 承包商提交施工明细图与有关单位复核。

ALL LOCATION / SETTING OUT TO BE CONFIRMED ON SITE BY CLIENT/DESIGN DESIGN CONSULTANT/CONTRACTOR. 所有标志位置/标志尺寸需由客户/设计师/项目承建商现场复核确认。

ALL MEASUREMENTS ARE TO BE CONFIRMED ON SITE BY CONTRACTOR. 所有标志尺寸应由项目承建商现场复核确认。

ALL QUANTITY TO BE VERIFIED BY CLIENT/QUANTITY SURVEYOR. 所有标志数量须经客户确认。

CONTRACTOR TO SUBMIT WATERPROOFING DETAIL. 项目承建商负责提交防水细节。

CONTRACTOR RESPONSIBLE FOR STRUCTURAL CALCULATION. 项目承建商应负责有关结构计算。



郑州市金水区北三环73号瀚海北金商务楼B座19A层  
19A floor, block B, Hanhai Beijing business building, 73 North Third Ring Road, Jinshui District, Zhengzhou  
www.hnwxbs.cn

T/F 0371-8606 0306  
18337166686  
13949057575  
18839776686

PROJECT TITLE 项目

CLIENT TITLE 客户

INFORMATION 设计说明

SCALE 图示

APPROVE 审定

CHECK 审核

CHARGE 负责人

DRAWING 制图

DATE 日期

DRAWING NO.

4.12.1

OUTDOOR  
SIGN PARTS

可移动温馨提示牌  
数量:10个



示意图-Sketch Map

备注NOTES:

THE COPYRIGHT OF THIS DRAWING IS OWNED BY HENAN VIENTIANE SIGN DESIGN CO., LTD. 此图版权归为河南万象标识设计有限公司所有。DESIGN INTENT ONLY CONTRACTOR TO SUBMIT SHOP-DRAWING FOR APPROVAL. 此图仅为施工指导图, 承包商提交施工明细图与有关单位核校。

ALL LOCATION / SETTING OUT TO BE CONFIRMED ON SITE BY CLIENT/DESIGN DESIGN CONSULTANT/CONTRACTOR. 所有标志位置/标志尺寸图由客户/设计师/项目承建商现场复核确认。

ALL MEASUREMENTS ARE TO BE CONFIRMED ON SITE BY CONTRACTOR. 所有标志尺寸应由项目承建商现场复核确认。

ALL QUANTITY TO BE VERIFIED BY CLIENT/QUANTITY SURVEYOR. 所有标志数量须经客户确认。

CONTRACTOR TO SUBMIT WATERPROOFING DETAIL. 项目承建商负责提交防水细节。

CONTRACTOR RESPONSIBLE FOR STRUCTURAL CALCULATION. 项目承建商应负责有关结构计算。



郑州市金水区北三环73号瀚海北金商务楼B座19A层  
19A floor, block B, Hanhai Beijing business building, 73 North Third Ring Road, Jinshui District, Zhengzhou  
www.hnwxbs.cn

T/F 0371-8606 0306  
18337166686  
13949057575  
18839776686

PROJECT TITLE 项目

CLIENT TITLE 客户

INFORMATION 设计说明

SCALE 图示

APPROVE 审定

CHECK 审核

CHARGE 负责人

DRAWING 制图

DATE 日期

DRAWING NO.

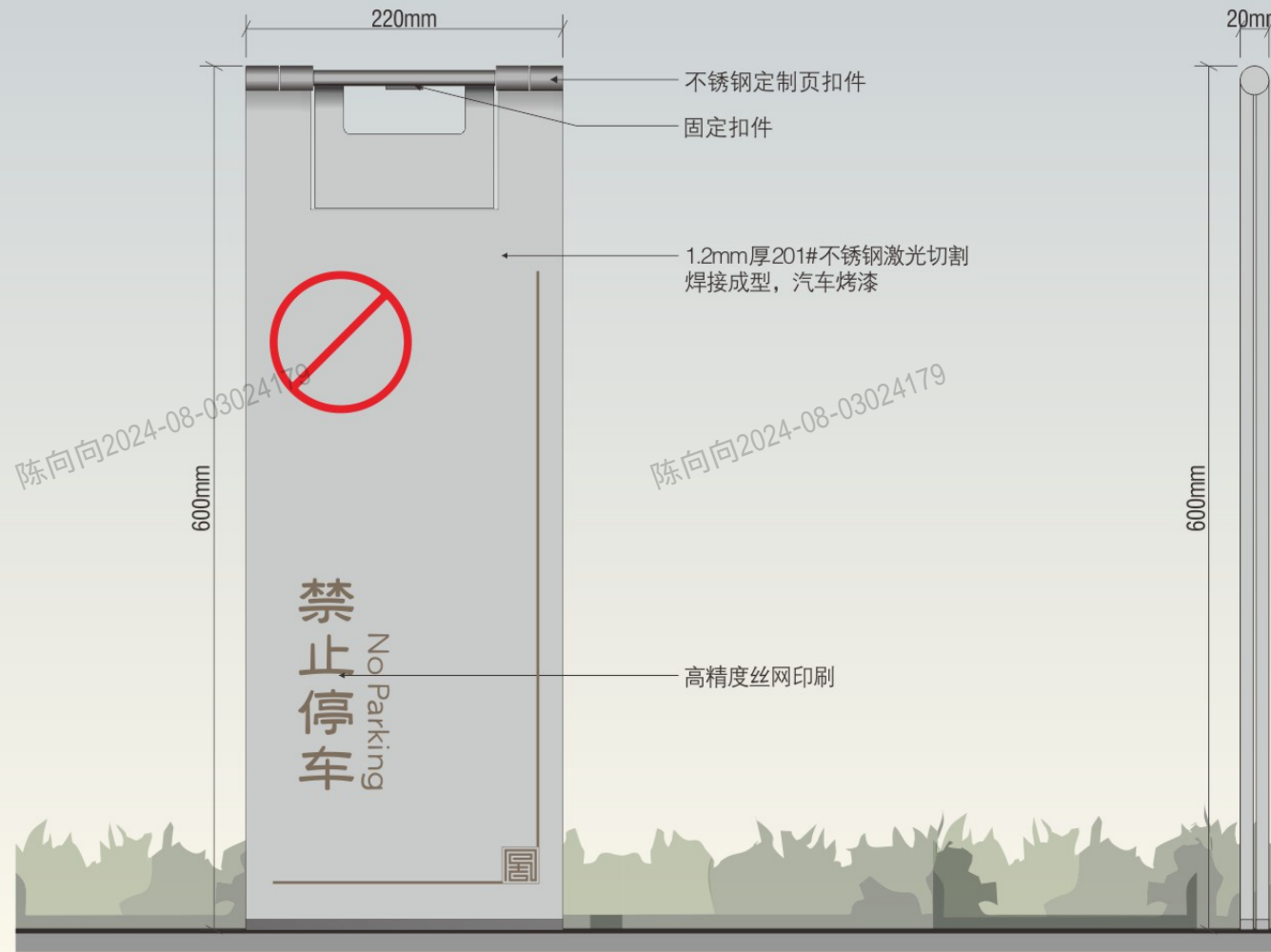

4 效果图-Elevation  
120

08-03024179

陈向向2024-08-03024179

陈向向2024-08-03024179

陈向向2024-08-03024179

陈向向2024-08-03024179

08-03024179

陈向向2024-08-03024179

陈向向2024-08-03024179

陈向向2024-08-03024179

陈向向2024-08-03024179

08-03024179

陈向向2024-08-03024179

陈向向2024-08-03024179

陈向向2024-08-03024179

陈向向2024-08-03024179

08-03024179

08-03024179

08-03024179

08-03024179

08-03024179

# 5.0

## TRAFFIC SIGNS

交通标识

# 5.1.1

## OUTDOOR SIGN PARTS

南侧地库指引标识

数量:1个



示意图-Sketch Map



1 立面 - Elevation  
1:10

面为1.2mm厚201#不锈钢,0.6mm厚不锈钢围边立体字,侧厚20mm,表面做乱纹古铜效果,背衬10mm厚磨砂亚克力,内置LED防水光源,侧发光

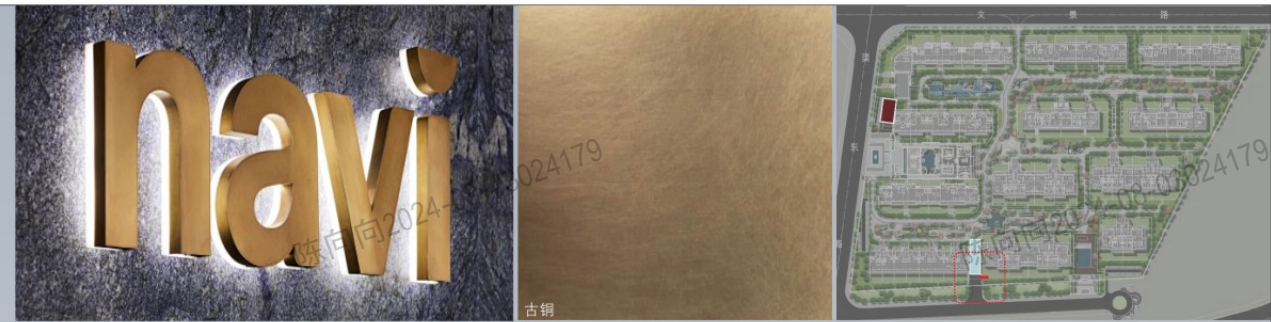
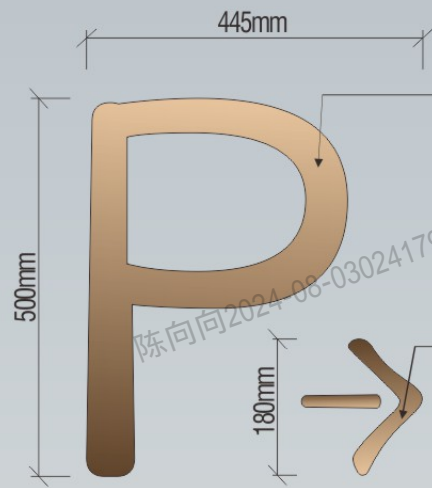
面为1.2mm厚201#不锈钢,0.6mm厚不锈钢围边立体字,侧厚10mm,表面做乱纹古铜效果,背衬5mm厚磨砂亚克力,内置LED防水光源,侧发光

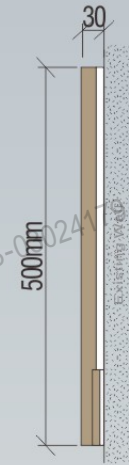

2 侧立面 - Side Elevation  
1:10

### 备注NOTES:

THE COPYRIGHT OF THIS DRAWING IS OWNED BY HENAN VIENTIANE SIGN DESIGN CO., LTD. 此图版权归为河南万象标识设计有限公司所有。DESIGN INTENT ONLY CONTRACTOR TO SUBMIT SHOP DRAWING FOR APPROVAL. 此图仅为施工指导图, 承包商须提交施工明细图与有关单位复核。  
ALL LOCATION / SETTING OUT TO BE CONFIRMED ON SITE BY CLIENT/DESIGN DESIGN CONSULTANT/CONTRACTOR. 所有标志位置/标志尺寸图须由客户/设计师/项目承建商现场复核确认。  
ALL MEASUREMENTS ARE TO BE CONFIRMED ON SITE BY CONTRACTOR. 所有标志尺寸应由项目承建商现场复核确认。  
ALL QUANTITY TO BE VERIFIED BY CLIENT/QUANTITY SURVEYOR. 所有标志数量须经客户确认。  
CONTRACTOR TO SUBMIT WATERPROOFING DETAIL. 项目承建商负责提交防水细节。  
CONTRACTOR RESPONSIBLE FOR STRUCTURAL CALCULATION. 项目承建商应负责有关结构计算。



郑州市金水区北三环73号瀚海北金商务楼B座19A层  
19A floor, block B, Hanhai Beijing business building, 73 North Third Ring Road, Jinshui District, Zhengzhou  
www.hnwxbs.cn

T/F 0371-8606 0306  
18337166686  
13949057575  
18839776686

PROJECT TITLE 项目

CLIENT TITLE 客户

INFORMATION 设计说明

SCALE 图示

APPROVE 审定

CHECK 审核

CHARGE 负责人

DRAWING 制图

DATE 日期

DRAWING NO.



# 5.2.1

## OUTDOOR SIGN PARTS

西侧地库指引标识

数量:1个



示意图-Sketch Map



古铜



### 备注NOTES:

THE COPYRIGHT OF THIS DRAWING IS OWNED BY HENAN VIENTIANE SIGN DESIGN CO., LTD. 此图版权归为河南万象标识设计有限公司所有。 DESIGN INTENT ONLY CONTRACTOR TO SUBMIT SHOP-DRAWING FOR APPROVAL. 此图仅为施工指导图, 承包商须提交施工明细图与有关单位审核。

ALL LOCATION / SETTING OUT TO BE CONFIRMED ON SITE BY CLIENT/DESIGN DESIGN CONSULTANT/CONTRACTOR. 所有标志位置/标志尺寸需由客户/设计师/项目承建商现场复核确认。

ALL MEASUREMENTS ARE TO BE CONFIRMED ON SITE BY CONTRACTOR. 所有标志尺寸应由项目承建商现场复核确认。

ALL QUANTITY TO BE VERIFIED BY CLIENT/QUANTITY SURVEYOR. 所有标志数量须经客户确认。

CONTRACTOR TO SUBMIT WATERPROOFING DETAIL. 项目承建商负责提交防水细节。

CONTRACTOR RESPONSIBLE FOR STRUCTURAL CALCULATION. 项目承建商应负责有关结构计算。



郑州市金水区北三环73号瀚海北金商务楼B座19A层

19A floor, block B, Hanhai Beijing business building, 73 North Third Ring Road, Jinshui District, Zhengzhou  
www.hnwxbs.cn

T/F 0371-8606 0306

18337166686

13949057575

18839776686

PROJECT TITLE 项目

CLIENT TITLE 客户

INFORMATION 设计说明

SCALE 图示

APPROVE 审定

CHECK 审核

CHARGE 负责人

DRAWING 制图

DATE 日期

DRAWING NO.



1 立面- Elevation  
1:10

面为1.2mm厚201#不锈钢,0.6mm厚不锈钢围边立体字,侧厚20mm,表面做乱纹古铜效果,背衬10mm厚磨砂亚克力,内置LED防水光源,侧发光

面为1.2mm厚201#不锈钢,0.6mm厚不锈钢围边立体字,侧厚10mm,表面做乱纹古铜效果,背衬5mm厚磨砂亚克力,内置LED防水光源,侧发光

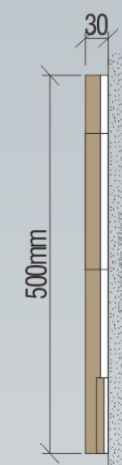

2 侧立面-Side Elevation  
1:10



# 5.3.1

## OUTDOOR SIGN PARTS

非机动车指引标识

数量:3个



古铜

示意图-Sketch Map

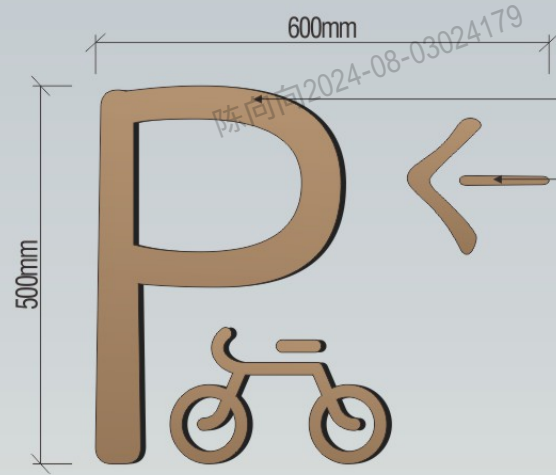

1 立面 - Elevation  
1:10

面为1.2mm厚201#不锈钢,0.6mm厚不锈钢  
围边立体字,侧厚20mm,表面做乱纹古铜效果

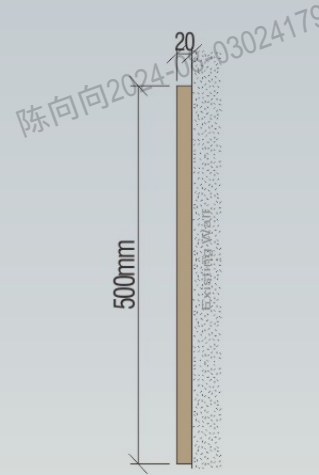

2 侧立面 - Side Elevation  
1:10

### 备注NOTES:

THE COPYRIGHT OF THIS DRAWING IS OWNED BY HENAN VIENTIANE SIGN DESIGN CO., LTD. 此图版权归河南万象标识设计有限公司所有。DESIGN INTENT ONLY CONTRACTOR TO SUBMIT SHOP-DRAWING FOR APPROVAL. 此图仅为施工指导图, 承包商须提交施工明细图与有关单位复核。

ALL LOCATION / SETTING OUT TO BE CONFIRMED ON SITE BY CLIENT/DESIGN DESIGN CONSULTANT/CONTRACTOR. 所有标志位置/标志尺寸需由客户/设计师/项目承建商现场复核确认。

ALL MEASUREMENTS ARE TO BE CONFIRMED ON SITE BY CONTRACTOR. 所有标志尺寸应由项目承建商现场复核确认。

ALL QUANTITY TO BE VERIFIED BY CLIENT/QUANTITY SURVEYOR. 所有标志数量须经客户确认。

CONTRACTOR TO SUBMIT WATERPROOFING DETAIL. 项目承建商负责提交防水细节。

CONTRACTOR RESPONSIBLE FOR STRUCTURAL CALCULATION. 项目承建商应负责有关结构计算。



郑州市金水区北三环73号瀚海北金商务楼B座19A层  
19A floor, block B, Hanhai Beijing business building, 73 North Third Ring Road, Jinshui District, Zhengzhou  
www.hnwxbs.cn

T/F 0371-8606 0306  
18337166686  
13949057575  
18839776686

PROJECT TITLE 项目

CLIENT TITLE 客户

INFORMATION 设计说明

SCALE 图示

APPROVE 审定

CHECK 审核

CHARGE 负责人

DRAWING 制图

DATE 日期

DRAWING NO.

# 5.4.1

## OUTDOOR SIGN PARTS

消防通道 请勿阻塞标识  
数量: 2个



### 备注NOTES:

THE COPYRIGHT OF THIS DRAWING IS OWNED BY HENAN VIENTIANE SIGN DESIGN CO., LTD. 此图版权归河南万象标识设计有限公司所有。DESIGN INTENT ONLY CONTRACTOR TO SUBMIT SHOP-DRAWING FOR APPROVAL. 此图仅为施工指导图, 承包商须提交施工明细图与有关单位复核。

ALL LOCATION / SETTING OUT TO BE CONFIRMED ON SITE BY CLIENT/DESIGNER/CONSULTANT/CONTRACTOR. 所有标志位置/标志尺寸须由客户/设计师/项目承建商现场复核确认。

ALL MEASUREMENTS ARE TO BE CONFIRMED ON SITE BY CONTRACTOR. 所有标志尺寸应由项目承建商现场复核确认。

ALL QUANTITY TO BE VERIFIED BY CLIENT/QUANTITY SURVEYOR. 所有标志数量须经客户确认。

CONTRACTOR TO SUBMIT WATERPROOFING DETAIL. 项目承建商负责提交防水细节。

CONTRACTOR RESPONSIBLE FOR STRUCTURAL CALCULATION. 项目承建商应负责有关结构计算。



郑州市金水区北三环73号瀚海北金商务楼B座19A层  
19A floor, block B, Hanhai Beijing business building, 73 North Third Ring Road, Jinshui District, Zhengzhou  
www.hnwxbs.cn

T/F 0371-8606 0306  
18337166686  
13949057575  
18839776686

PROJECT TITLE 项目

CLIENT TITLE 客户

INFORMATION 设计说明

SCALE 图示

APPROVE 审定

CHECK 审核

CHARGE 负责人

DRAWING 制图

DATE 日期

DRAWING NO.

08-03024179

陈向向2024-08-03024179

陈向向2024-08-03024179

陈向向2024-08-03024179

陈向向2024-08-03024179

08-03024179

陈向向2024-08-03024179

陈向向2024-08-03024179

陈向向2024-08-03024179

陈向向2024-08-03024179

08-03024179

陈向向2024-08-03024179

陈向向2024-08-03024179

陈向向2024-08-03024179

陈向向2024-08-03024179

08-03024179

08-03024179

08-03024179

08-03024179

08-03024179

# 6.0

BUILDING SIGNAGE

楼宇标识

室内分析  
INDOOR ANALYSIS

质美

EXQUISITE  
WARM ELEGANT

精致/温润/雅致

构成 色彩 细节



# 6.1.1

## OUTDOOR SIGN PARTS

楼栋号标识

数量: 24个[共计12栋]

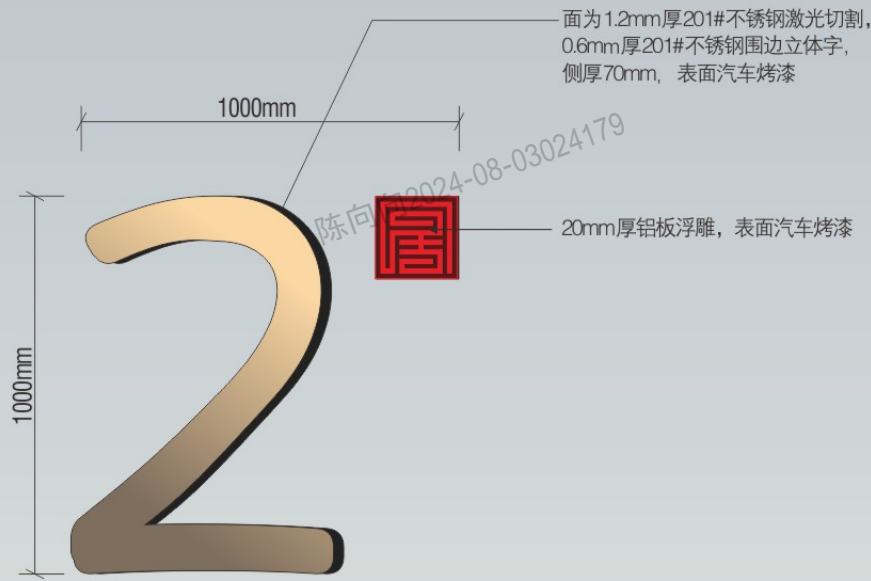

1 立面 - Elevation  
1:10

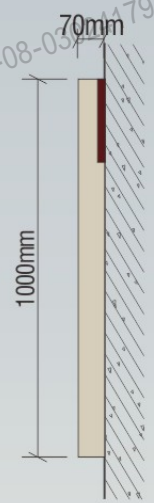

2 侧立面 - Side Elevation  
1:10



### 备注NOTES:

THE COPYRIGHT OF THIS DRAWING IS OWNED BY HENAN VIENTIANE SIGN DESIGN CO., LTD. 此图纸版权为河南万象标识设计有限公司所有  
DESIGN INTENT ONLY CONTRACTOR TO SUBMIT SHOP-DRAWING FOR APPROVAL  
此图仅为施工指导图, 承包商须提交施工明细图与有关单位复核

ALL LOCATION / SETTING OUT TO BE CONFIRMED ON SITE BY CLIENT/DESIGN DESIGN CONSULTANT/CONTRACTOR  
所有标志位置/标志尺寸图须由客户/设计师/项目承建商现场复核确认

ALL MEASUREMENTS ARE TO BE CONFIRMED ON SITE BY CONTRACTOR  
所有标志尺寸应由项目承建商现场复核确认

ALL QUANTITY TO BE VERIFIED BY CLIENT/QUANTITY SURVEYOR  
所有标志数量须经客户确认

CONTRACTOR TO SUBMIT WATERPROOFING DETAIL. 项目承建商负责提交防水细节

CONTRACTOR RESPONSIBLE FOR STRUCTURAL CALCULATION. 项目承建商应负责有关结构计算



郑州市金水区北三环73号瀚海北金商务楼B座19A层  
19A floor, block B, Hanhai Beijing business building, 73 North Third Ring Road, Jinshui District, Zhengzhou  
www.hnwxbs.cn

T/F 0371-8606 0306  
18337166686  
13949057575  
18839776686

PROJECT TITLE 项目

CLIENT TITLE 客户

INFORMATION 设计说明

SCALE 图示

APPROVE 审定

CHECK 审核

CHARGE 负责人

DRAWING 制图

DATE 日期

DRAWING NO.

6.1.2

OUTDOOR  
SIGN PARTS

楼栋号标识-其他字体

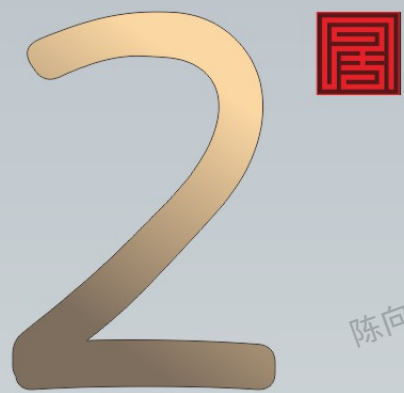

备注NOTES:

THE COPYRIGHT OF THIS DRAWING IS OWNED BY HENAN VIENTIANE SIGN DESIGN CO., LTD. 此图版权归河南万象标识设计有限公司所有。 DESIGN INTENT ONLY CONTRACTOR TO SUBMIT SHOP-DRAWING FOR APPROVAL. 此图仅为施工指导图, 承包商须提交施工明细图与有关单位复核。

ALL LOCATION / SETTING OUT TO BE CONFIRMED ON SITE BY CLIENT/DESIGN DESIGN CONSULTANT/CONTRACTOR. 所有标志位置/标志尺寸图须由客户/设计师/项目承包商现场复核确认。

ALL MEASUREMENTS ARE TO BE CONFIRMED ON SITE BY CONTRACTOR. 所有标志尺寸应由项目承包商现场复核确认。

ALL QUANTITY TO BE VERIFIED BY CLIENT/QUANTITY SURVEYOR. 所有标志数量须经客户确认。

CONTRACTOR TO SUBMIT WATERPROOFING DETAIL. 项目承包商负责提交防水细节。

CONTRACTOR RESPONSIBLE FOR STRUCTURAL CALCULATION. 项目承包商应负责有关结构计算。



郑州市金水区北三环73号瀚海北金商务楼B座19A层  
19A floor, block B, Hanhai Beijing business building, 73 North Third Ring Road, Jinshui District, Zhengzhou  
www.hnwxbs.cn

T/F 0371-8606 0306  
18337166686  
13949057575  
18839776686

PROJECT TITLE 项目

CLIENT TITLE 客户

INFORMATION 设计说明

SCALE 图示

APPROVE 审定

CHECK 审核

CHARGE 负责人

DRAWING 制图

DATE 日期

DRAWING NO.



陈向向2024-08-03024179

陈向向2024-08-03024179

陈向向2024-08-03024179

08-03024179

陈向向2024-08-03024179

陈向向2024-08-03024179

陈向向2024-08-03024179

陈向向2024-08-03024179

08-03024179

陈向向2024-08-03024179

陈向向2024-08-03024179

陈向向2024-08-03024179

陈向向2024-08-03024179

08-03024179

08-03024179

08-03024179

08-03024179

2



# 6.2.1

## OUTDOOR SIGN PARTS

单元号标识  
数量: 28个



示意图-SKETCH MAP



古铜

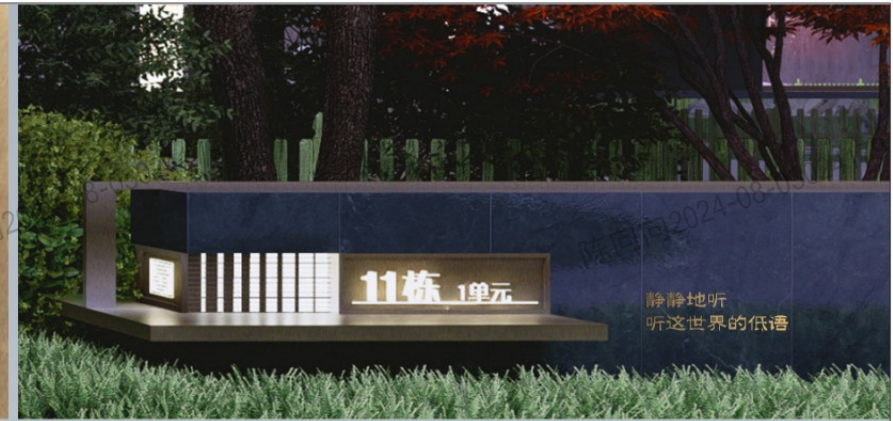

### 备注NOTES:

THE COPYRIGHT OF THIS DRAWING IS OWNED BY HENAN VIENTIANE SIGN DESIGN CO., LTD. 此图纸版权为河南万象标识设计有限公司所有。DESIGN INTENT ONLY CONTRACTOR TO SUBMIT SHOP DRAWING FOR APPROVAL. 此图仅为施工指导图, 承包商须提交施工明细图与有关单位复核。

ALL LOCATION / SETTING OUT TO BE CONFIRMED ON SITE BY CLIENT/DESIGN DESIGN CONSULTANT/CONTRACTOR. 所有标志位置/标志尺寸图须由客户/设计师/项目承包商现场复核确认。

ALL MEASUREMENTS ARE TO BE CONFIRMED ON SITE BY CONTRACTOR. 所有标志尺寸应由项目承包商现场复核确认。

ALL QUANTITY TO BE VERIFIED BY CLIENT/QUANTITY SURVEYOR. 所有标志数量须经客户确认。

CONTRACTOR TO SUBMIT WATERPROOFING DETAIL. 项目承包商负责提交防水细节。

CONTRACTOR RESPONSIBLE FOR STRUCTURAL CALCULATION. 项目承包商应负责有关结构计算。



郑州市金水区北三环73号瀚海北金商务楼B座19A层  
19A floor, block B, Hanhai Beijing business building, 73 North Third Ring Road, Jinshui District, Zhengzhou  
www.hnwxbs.cn

T/F 0371-8606 0306  
18337166686  
13949057575  
18839776686

PROJECT TITLE 项目

CLIENT TITLE 客户

INFORMATION 设计说明

SCALE 图示

APPROVE 审定

CHECK 审核

CHARGE 负责人

DRAWING 制图

DATE 日期

DRAWING NO.

静静地听  
听这世界的低语

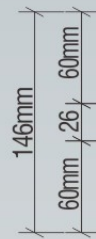

1 正立面-Side Elevation  
1:10

5mm厚201#不锈钢激光切割成型  
表面做乱纹古铜效果



2 侧立面-Side Elevation  
1:10

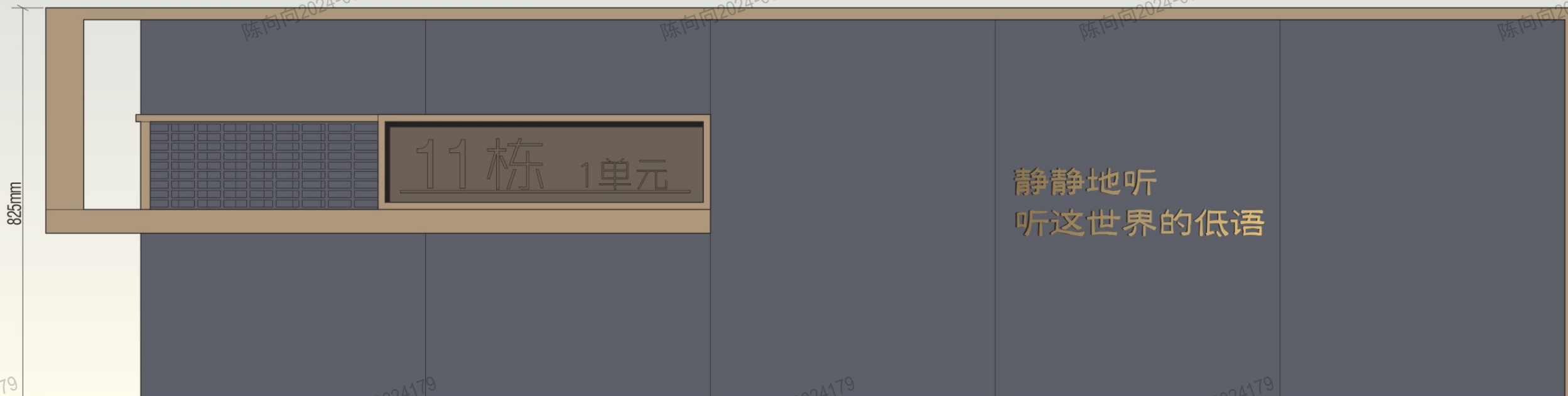

825mm

# 6.3.1

## INDOOR SIGN PARTS

室内公告栏标识  
数量: 28个



示意图-SKETCH MAP

### 备注NOTES:

THE COPYRIGHT OF THIS DRAWING IS OWNED BY HENAN VIENTIANE SIGN DESIGN CO., LTD. 此图版权归河南万象标识设计有限公司所有  
DESIGN INTENT ONLY CONTRACTOR TO SUBMIT SHOP-DRAWING FOR APPROVAL.  
此图仅为施工指导图, 承包商须提交施工明细图与有关单位复核  
ALL LOCATION / SETTING OUT TO BE CONFIRMED ON SITE BY CLIENT/DESIGN DESIGN CONSULTANT/CONTRACTOR.  
所有标志位置/标志尺寸须由客户/设计师/项目承建商现场复核确认  
ALL MEASUREMENTS ARE TO BE CONFIRMED ON SITE BY CONTRACTOR.  
所有标志尺寸应由项目承建商现场复核确认  
ALL QUANTITY TO BE VERIFIED BY CLIENT/QUANTITY SURVEYOR.  
所有标志数量须经客户确认  
CONTRACTOR TO SUBMIT WATERPROOFING DETAIL.  
项目承建商负责提交防水细节  
CONTRACTOR RESPONSIBLE FOR STRUCTURAL CALCULATION.  
项目承建商应负责有关结构计算



郑州市金水区北三环73号瀚海北金商务楼B座19A层  
19A floor, block B, Hanhai Beijing business building, 73 North Third Ring Road, Jinshui District, Zhengzhou  
www.hnwxbs.cn  
T/F 0371-8606 0306  
18337166686  
13949057575  
18839776686

### PROJECT TITLE 项目

### CLIENT TITLE 客户

### INFORMATION 设计说明

### SCALE 图示

### APPROVE 审定

### CHECK 审核

### CHARGE 负责人

### DRAWING 制图

### DATE 日期

### DRAWING NO.

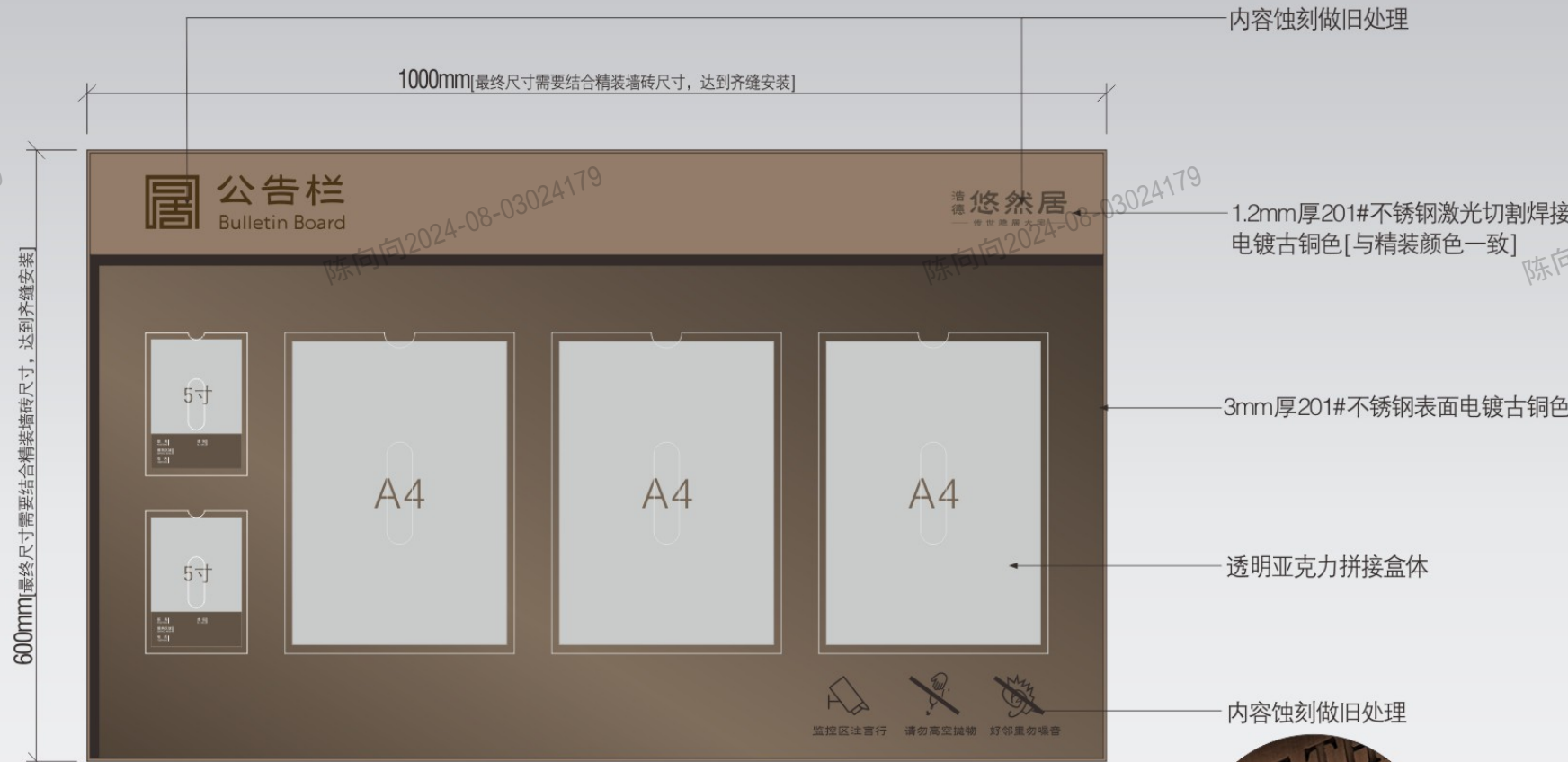

1 正立面-Side Elevation  
1:10

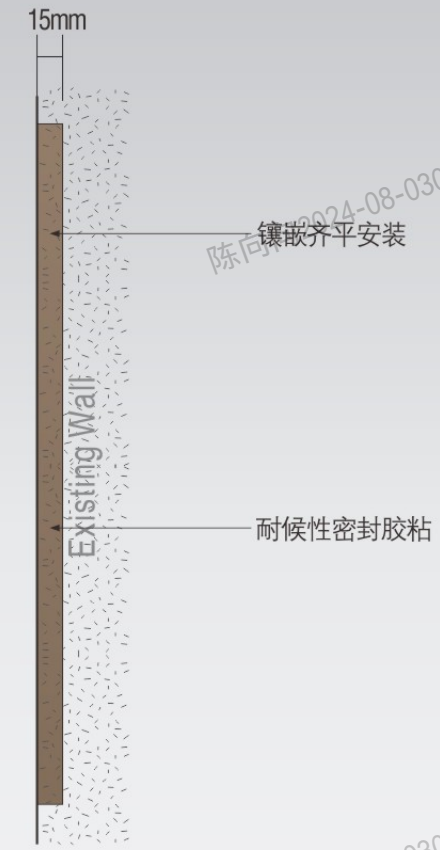

2 侧立面-Side Elevation  
1:10



# 6.4.1

## INDOOR SIGNS PARTS

玻璃防撞条标识  
数量：200米



### 备注NOTES:

THE COPYRIGHT OF THIS DRAWING IS OWNED BY HENAN VIENTIANE SIGN DESIGN CO., LTD. 此图版权归为河南万象标识设计有限公司所有。 DESIGN INTENT ONLY CONTRACTOR TO SUBMIT SHOP DRAWING FOR APPROVAL. 此图仅为施工指导图, 承包商须提交施工明细图与有关单位复核。

ALL LOCATION / SETTING OUT TO BE CONFIRMED ON SITE BY CLIENT/DESIGN DESIGN CONSULTANT/CONTRACTOR. 所有标志位置/标志尺寸需由客户/设计师/项目承建商现场复核确认。

ALL MEASUREMENTS ARE TO BE CONFIRMED ON SITE BY CONTRACTOR. 所有标志尺寸应由项目承建商现场复核确认。

ALL QUANTITY TO BE VERIFIED BY CLIENT/QUANTITY SURVEYOR. 所有标志数量须经客户确认。

CONTRACTOR TO SUBMIT WATERPROOFING DETAIL. 项目承建商负责提交防水细节。 CONTRACTOR RESPONSIBLE FOR STRUCTURAL CALCULATION. 项目承建商应负责有关结构计算。



郑州市金水区北三环73号瀚海北金商务楼B座19A层  
19A floor, block B, Hanhai Beijing business building, 73 North Third Ring Road, Jinshui District, Zhengzhou  
www.hnwxbs.cn

T/F 0371-8606 0306  
18337166686  
13949057575  
18839776686

### PROJECT TITLE 项目

### CLIENT TITLE 客户

### INFORMATION 设计说明

### SCALE 图示

### APPROVE 审定

### CHECK 审核

### CHARGE 负责人

### DRAWING 制图

### DATE 日期

### DRAWING NO.



# 6.5.1

## INDOOR SIGNS PARTS

单元入口标识  
数量: 28个

陈向向2024-08-03024179

陈向向2024-08-03024179

陈向向2024-08-03024179

15mm厚乱纹铝板CNC三维雕刻锥形立体字  
表面做乱纹古铜效果,背支杆悬空安装

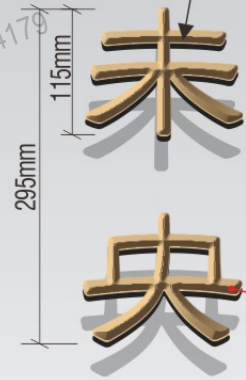

1 正立面 - Front Elevation  
1:10

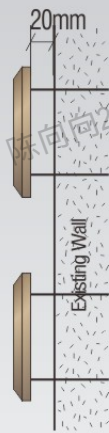

2 侧立面 - Side Elevation  
1:10

2360mm

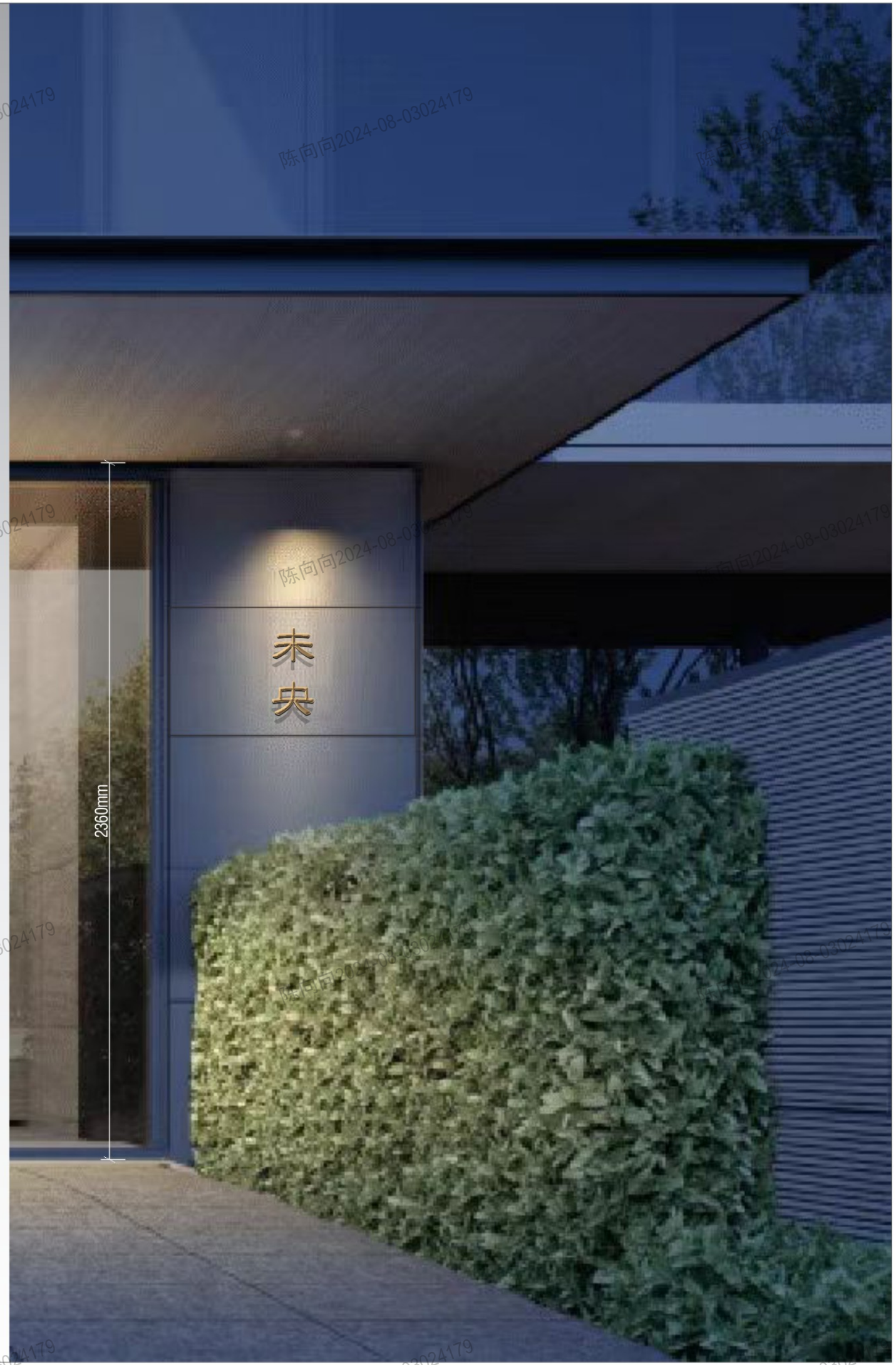

### 备注NOTES:

THE COPYRIGHT OF THIS DRAWING IS OWNED BY HENAN VIENTIANE SIGN DESIGN CO., LTD. 此图版权归河南万象标识设计有限公司所有。DESIGN INTENT ONLY CONTRACTOR TO SUBMIT SHOP-DRAWING FOR APPROVAL. 此图仅为施工指导图, 承包商提交施工明细图与有关单位核校。

ALL LOCATION / SETTING OUT TO BE CONFIRMED ON SITE BY CLIENT/DESIGNER/CONSULTANT/CONTRACTOR. 所有标志位置/标志尺寸由客户/设计师/项目承建商现场复核确认。

ALL MEASUREMENTS ARE TO BE CONFIRMED ON SITE BY CONTRACTOR. 所有标志尺寸应由项目承建商现场复核确认。

ALL QUANTITY TO BE VERIFIED BY CLIENT/QUANTITY SURVEYOR. 所有标志数量须经客户确认。

CONTRACTOR TO SUBMIT WATERPROOFING DETAIL. 项目承建商负责提交防水细节。

CONTRACTOR RESPONSIBLE FOR STRUCTURAL CALCULATION. 项目承建商应负责有关结构计算。



郑州市金水区北三环73号瀚海北金商务楼B座19A层  
19A floor, block B, Hanhai Beijing business building, 73 North Third Ring Road, Jinshui District, Zhengzhou  
www.hnwxbs.cn

T/F 0371-8606 0306  
18337166686  
13949057575  
18839776686

PROJECT TITLE 项目

CLIENT TITLE 客户

INFORMATION 设计说明

SCALE 图示

APPROVE 审定

CHECK 审核

CHARGE 负责人

DRAWING 制图

DATE 日期

DRAWING NO.

陈向向2024-08-03024179

陈向向2024-08-03024179

陈向向2024-08-03024179

陈向向2024-08-03024179

陈向向2024-08-03024179

陈向向2024-08-03024179

陈向向2024-08-03024179

08-03024179

陈向向2024-08-03024179

陈向向2024-08-03024179

陈向向2024-08-03024179

陈向向2024-08-03024179

陈向向2024-08-03024179

陈向向2024-08-03024179

陈向向2024-08-03024179

陈向向2024-08-03024179

陈向向2024-08-03024179

陈向向2024-08-03024179

陈向向2024-08-03024179

08-03024179

2024-08-03024179

2024-08-03024179

2024-08-03024179

2024-08-03024179

未央

# 6.6.1

## INDOOR SIGNS PARTS

电梯楼层标识

数量: 220个



示意图-Sketch Map

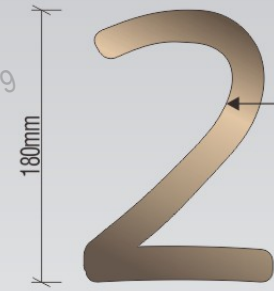

1 立面- Elevation 1:5

面为1.2mm厚201#不锈钢,0.6mm厚不锈钢围边立体字,侧厚10mm,表面电镀古铜色



2 侧立面-Side Elevation 1:5

0 1 2 3 4 5 6 7 8 9



### 备注NOTES:

THE COPYRIGHT OF THIS DRAWING IS OWNED BY HENAN VIENTIANE SIGN DESIGN CO., LTD. 此图版权归河南万象标识设计有限公司所有. DESIGN INTENT ONLY CONTRACTOR TO SUBMIT SHOP DRAWING FOR APPROVAL. 此图仅为施工指导图, 承包商须提交施工明细图与有关单位复核.

ALL LOCATION / SETTING OUT TO BE CONFIRMED ON SITE BY CLIENT/DESIGN DESIGN CONSULTANT/CONTRACTOR. 所有标志位置/标志尺寸图须由客户/设计师/项目承建商现场复核确认.

ALL MEASUREMENTS ARE TO BE CONFIRMED ON SITE BY CONTRACTOR. 所有标志尺寸应由项目承建商现场复核确认.

ALL QUANTITY TO BE VERIFIED BY CLIENT/QUANTITY SURVEYOR. 所有标志数量须经客户确认.

CONTRACTOR TO SUBMIT WATERPROOFING DETAIL. 项目承建商负责提交防水细节.

CONTRACTOR RESPONSIBLE FOR STRUCTURAL CALCULATION. 项目承建商应负责有关结构计算.



郑州市金水区北三环73号瀚海北金商务楼B座19A层  
19A floor, block B, Hanhai Beijing business building, 73 North Third Ring Road, Jinshui District, Zhengzhou  
www.hnwxbs.cn

T/F 0371-8606 0306  
18337166686  
13949057575  
18839776686

PROJECT TITLE 项目

CLIENT TITLE 客户

INFORMATION 设计说明

SCALE 图示

APPROVE 审定

CHECK 审核

CHARGE 负责人

DRAWING 制图

DATE 日期

DRAWING NO.

# 6.7.1

## INDOOR SIGNS PARTS

门牌号标识

数量: 250个

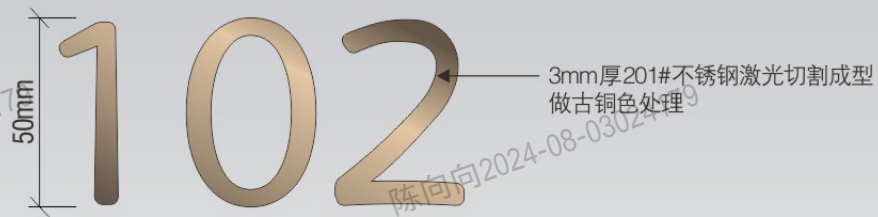

1 立面 - Elevation  
1:2

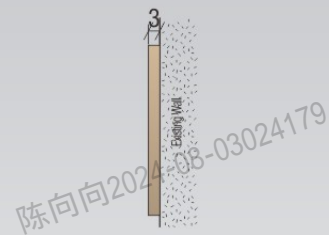

2 侧立面 - Side Elevation  
1:2

0 1 2 3 4 5 6 7 8 9



### 备注NOTES:

THE COPYRIGHT OF THIS DRAWING IS OWNED BY HENAN VIENTIANE SIGN DESIGN CO., LTD. 此图版权归河南万象标识设计有限公司所有。 DESIGN INTENT ONLY CONTRACTOR TO SUBMIT SHOP DRAWING FOR APPROVAL. 此图仅为施工指导图, 承包商提交施工明细图与有关单位复核。

ALL LOCATION / SETTING OUT TO BE CONFIRMED ON SITE BY CLIENT/DESIGN DESIGN CONSULTANT/CONTRACTOR. 所有标志位置/标志尺寸图须由客户/设计师/项目承包商现场复核确认。

ALL MEASUREMENTS ARE TO BE CONFIRMED ON SITE BY CONTRACTOR. 所有标志尺寸应由项目承包商现场复核确认。

ALL QUANTITY TO BE VERIFIED BY CLIENT/QUANTITY SURVEYOR. 所有标志数量须经客户确认。

CONTRACTOR TO SUBMIT WATERPROOFING DETAIL. 项目承包商负责提交防水细节。

CONTRACTOR RESPONSIBLE FOR STRUCTURAL CALCULATION. 项目承包商应负责有关结构计算。



郑州市金水区北三环73号瀚海北金商务楼B座19A层  
19A floor, block B, Hanhai Beijing business building, 73 North Third Ring Road, Jinshui District, Zhengzhou  
www.hnwxbs.cn

T/F 0371-8606 0306  
18337166686  
13949057575  
18839776686

PROJECT TITLE 项目

CLIENT TITLE 客户

INFORMATION 设计说明

SCALE 图示

APPROVE 审定

CHECK 审核

CHARGE 负责人

DRAWING 制图

DATE 日期

DRAWING NO.

# 6.8.1

## INDOOR SIGNS PARTS

设备间标识

数量: 351个

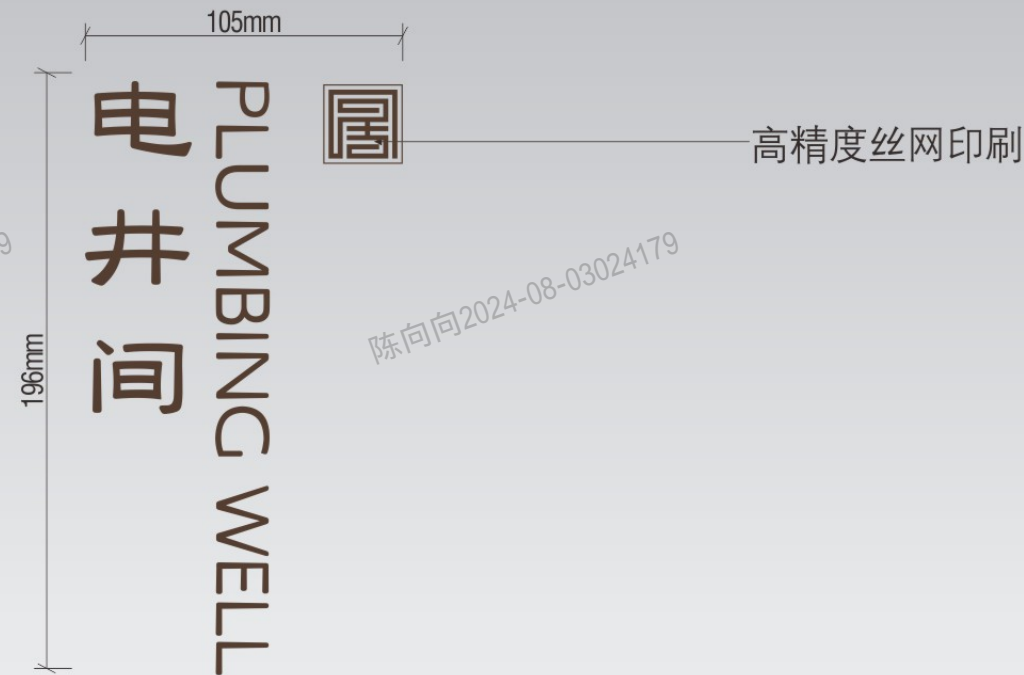

1 立面 - Elevation  
1:2

电井间  
ELECTRIC WELL ROOM

数量: 173个

水暖井  
WATER HEATING WELL

数量: 177个

配电间  
Power distribution room

数量: 1个



### 备注NOTES:

THE COPYRIGHT OF THIS DRAWING IS OWNED BY HENAN VIENTIANE SIGN DESIGN CO., LTD. 此图版权归为河南万象标识设计有限公司所有  
DESIGN INTENT ONLY CONTRACTOR TO SUBMIT SHOP DRAWING FOR APPROVAL  
此图仅为施工指导图, 承包商提交施工明细图与有关单位复核  
ALL LOCATION / SETTING OUT TO BE CONFIRMED ON SITE BY CLIENT/DESIGN DESIGN CONSULTANT/CONTRACTOR  
所有标志位置/标志尺寸图须由客户/设计师/项目承包商现场复核确认  
ALL MEASUREMENTS ARE TO BE CONFIRMED ON SITE BY CONTRACTOR  
所有标志尺寸应由项目承包商现场复核确认  
ALL QUANTITY TO BE VERIFIED BY CLIENT/QUANTITY SURVEYOR  
所有标志数量须经客户确认  
CONTRACTOR TO SUBMIT WATERPROOFING DETAIL  
项目承包商负责提交防水细节  
CONTRACTOR RESPONSIBLE FOR STRUCTURAL CALCULATION  
项目承包商负责有关结构计算



郑州市金水区北三环73号瀚海北金商务楼B座19A层  
19A floor, block B, Hanhai Beijing business building, 73 North Third Ring Road, Jinshui District, Zhengzhou  
www.hnwxbs.cn

T/F 0371-8606 0306  
18337166686  
13949057575  
18839776686

PROJECT TITLE 项目

CLIENT TITLE 客户

INFORMATION 设计说明

SCALE 图例

APPROVE 审定

CHECK 审核

CHARGE 负责人

DRAWING 制图

DATE 日期

DRAWING NO.

# 6.9.1

## INDOOR SIGNS PARTS

消火栓标识

数量:184个



1 立面 - Elevation  
1:3



### 备注NOTES:

THE COPYRIGHT OF THIS DRAWING IS OWNED BY HENAN VIENTIANE SIGN DESIGN CO., LTD. 此图版权归河南万象标识设计有限公司所有。DESIGN INTENT ONLY CONTRACTOR TO SUBMIT SHOP-DRAWING FOR APPROVAL. 此图仅为施工指导图, 承包商提交施工明细图与有关单位核校。

ALL LOCATION / SETTING OUT TO BE CONFIRMED ON SITE BY CLIENT/DESIGN DESIGN CONSULTANT/CONTRACTOR. 所有标志位置/标志尺寸由客户/设计师/项目承包商现场确认。

ALL MEASUREMENTS ARE TO BE CONFIRMED ON SITE BY CONTRACTOR. 所有标志尺寸应由项目承包商现场确认。

ALL QUANTITY TO BE VERIFIED BY CLIENT/QUANTITY SURVEYOR. 所有标志数量须经客户确认。

CONTRACTOR TO SUBMIT WATERPROOFING DETAIL. 项目承包商负责提交防水细节。

CONTRACTOR RESPONSIBLE FOR STRUCTURAL CALCULATION. 项目承包商应负责有关结构计算。



郑州市金水区北三环73号瀚海北金商务楼B座19A层  
19A floor, block B, Hanhai Beijing business building, 73 North Third Ring Road, Jinshui District, Zhengzhou  
www.hnwxbs.cn

T/F 0371-8606 0306  
18337166686  
13949057575  
18839776686

PROJECT TITLE 项目

CLIENT TITLE 客户

INFORMATION 设计说明

SCALE 图示

APPROVE 审定

CHECK 审核

CHARGE 负责人

DRAWING 制图

DATE 日期

DRAWING NO.

# 6.10.1

## INDOOR SIGNS PARTS

如遇火警  
请勿使用电梯  
数量:285个



1 立面- Elevation  
1:1



### 备注NOTES:

THE COPYRIGHT OF THIS DRAWING IS OWNED BY HENAN VIENTIANE SIGN DESIGN CO., LTD. 此图版权归为河南万象标识设计有限公司所有。 DESIGN INTENT ONLY CONTRACTOR TO SUBMIT SHOP DRAWING FOR APPROVAL. 此图仅为施工指导图, 承包商提交施工明细图与有关单位复核。

ALL LOCATION / SETTING OUT TO BE CONFIRMED ON SITE BY CLIENT/DESIGN DESIGN CONSULTANT/CONTRACTOR. 所有标志位置/标志尺寸需由客户/设计师/项目承包商现场复核确认。

ALL MEASUREMENTS ARE TO BE CONFIRMED ON SITE BY CONTRACTOR. 所有标志尺寸应由项目承包商现场复核确认。

ALL QUANTITY TO BE VERIFIED BY CLIENT/QUANTITY SURVEYOR. 所有标志数量须经客户确认。

CONTRACTOR TO SUBMIT WATERPROOFING DETAIL. 项目承包商负责提交防水细节。

CONTRACTOR RESPONSIBLE FOR STRUCTURAL CALCULATION. 项目承包商负责有关结构计算。



郑州市金水区北三环73号瀚海北金商务楼B座19A层  
19A floor, block B, Hanhai Beijing business building, 73 North Third Ring Road, Jinshui District, Zhengzhou  
www.hnwxbs.cn

T/F 0371-8606 0306  
18337166686  
13949057575  
18839776686

PROJECT TITLE 项目

CLIENT TITLE 客户

INFORMATION 设计说明

SCALE 图例

APPROVE 审定

CHECK 审核

CHARGE 负责人

DRAWING 制图

DATE 日期

DRAWING NO.

6.11.1

INDOOR  
SIGNS PARTS

消防疏散图标识

数量:240个

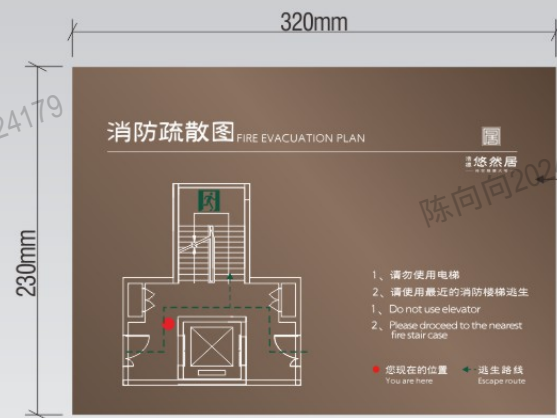

3mm厚亚克力激光切割,  
背喷漆背丝印



2 侧立面-Side Elevation  
1:5



备注NOTES:

THE COPYRIGHT OF THIS DRAWING IS OWNED BY HENAN VIENTIANE SIGN DESIGN CO., LTD. 此图纸版权为河南万象标识设计有限公司所有。DESIGN INTENT ONLY. CONTRACTOR TO SUBMIT SHOP-DRAWING FOR APPROVAL. 此图仅为施工指导图, 承包商须提交施工明细图与有关单位复核。

ALL LOCATION / SETTING OUT TO BE CONFIRMED ON SITE BY CLIENT/DESIGNER/DESIGN CONSULTANT/CONTRACTOR. 所有标志位置/标志尺寸须由客户/设计师/项目承建商现场复核确认。

ALL MEASUREMENTS ARE TO BE CONFIRMED ON SITE BY CONTRACTOR. 所有标志尺寸应由项目承建商现场复核确认。

ALL QUANTITY TO BE VERIFIED BY CLIENT/QUANTITY SURVEYOR. 所有标志数量须经客户确认。

CONTRACTOR TO SUBMIT WATERPROOFING DETAIL. 项目承建商负责提交防水细节。

CONTRACTOR RESPONSIBLE FOR STRUCTURAL CALCULATION. 项目承建商负责有关结构计算。



郑州市金水区北三环73号瀚海北金商务楼B座19A层  
19A floor, block B, Hanhai Beijing business building, 73 North Third Ring Road, Jinshui District, Zhengzhou  
www.hnwxbs.cn

T/F 0371-8606 0306  
18337166686  
13949057575  
18839776686

PROJECT TITLE 项目

CLIENT TITLE 客户

INFORMATION 设计说明

SCALE 图示

APPROVE 审定

CHECK 审核

CHARGE 负责人

DRAWING 制图

DATE 日期

DRAWING NO.

# 6.12.1

## INDOOR SIGNS PARTS

电梯内温馨提示牌

数量:39个



1 正立面- Front Elevation  
1:5

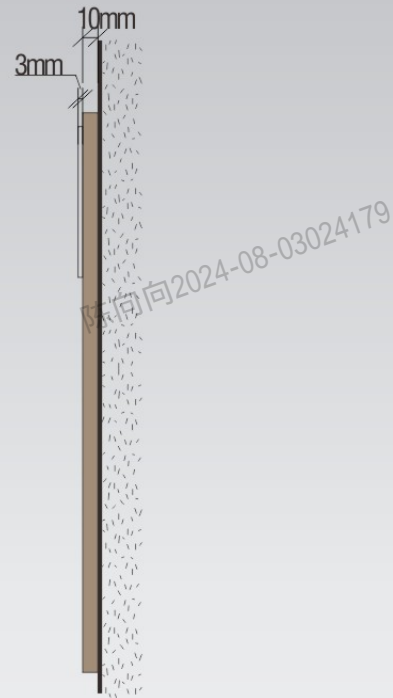

2 侧立面- Side Elevation  
1:5

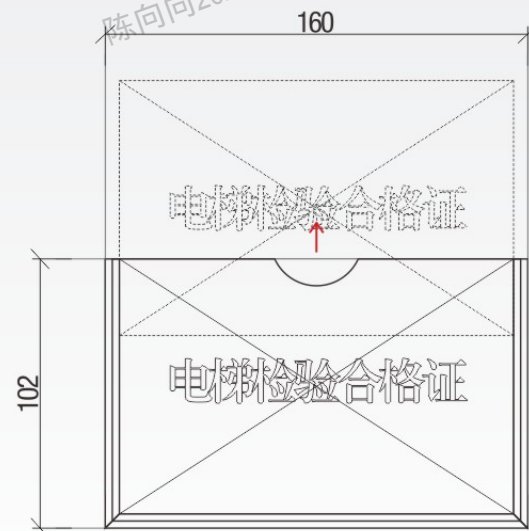

3 尺寸详图- Section Detail  
1:5



### 备注NOTES:

THE COPYRIGHT OF THIS DRAWING IS OWNED BY HENAN VIENTIANE SIGN DESIGN CO., LTD. 此图版权归河南万象标识设计有限公司所有. DESIGN INTENT ONLY CONTRACTOR TO SUBMIT SHOP-DRAWING FOR APPROVAL. 此图仅为施工指导用, 承包商需提供施工明细图与有关单位复核.

ALL LOCATION / SETTING OUT TO BE CONFIRMED ON SITE BY CLIENT/DESIGNER/DESIGN CONSULTANT/CONTRACTOR. 所有标志位置/标志尺寸图须由客户/设计师/项目承建商现场复核确认.

ALL MEASUREMENTS ARE TO BE CONFIRMED ON SITE BY CONTRACTOR. 所有标志尺寸应由项目承建商现场复核确认.

ALL QUANTITY TO BE VERIFIED BY CLIENT/QUANTITY SURVEYOR. 所有标志数量须经客户确认.

CONTRACTOR TO SUBMIT WATERPROOFING DETAIL. 项目承建商负责提交防水细节.

CONTRACTOR RESPONSIBLE FOR STRUCTURAL CALCULATION. 项目承建商应负责有关结构计算.



郑州市金水区北三环73号瀚海北金商务楼B座19A层  
19A floor, block B, Hanhai Beijing business building, 73 North Third Ring Road, Jinshui District, Zhengzhou  
www.hnwxbs.cn

T/F 0371-8606 0306  
18337166686  
13949057575  
18839776686

PROJECT TITLE 项目

CLIENT TITLE 客户

INFORMATION 设计说明

SCALE 图例

APPROVE 审定

CHECK 审核

CHARGE 负责人

DRAWING 制图

DATE 日期

DRAWING NO.

08-03024179

陈向向2024-08-03024179

陈向向2024-08-03024179

陈向向2024-08-03024179

陈向向2024-08-03024179

08-03024179

陈向向2024-08-03024179

陈向向2024-08-03024179

陈向向2024-08-03024179

陈向向2024-08-03024179

08-03024179

陈向向2024-08-03024179

陈向向2024-08-03024179

陈向向2024-08-03024179

陈向向2024-08-03024179

08-03024179

08-03024179

08-03024179

08-03024179

08-03024179

# 7.0

BASEMENT SIGNAGE

地库标识

# 地库引导进入流程

PARKING GUIDANCE INTO THE PROCESS

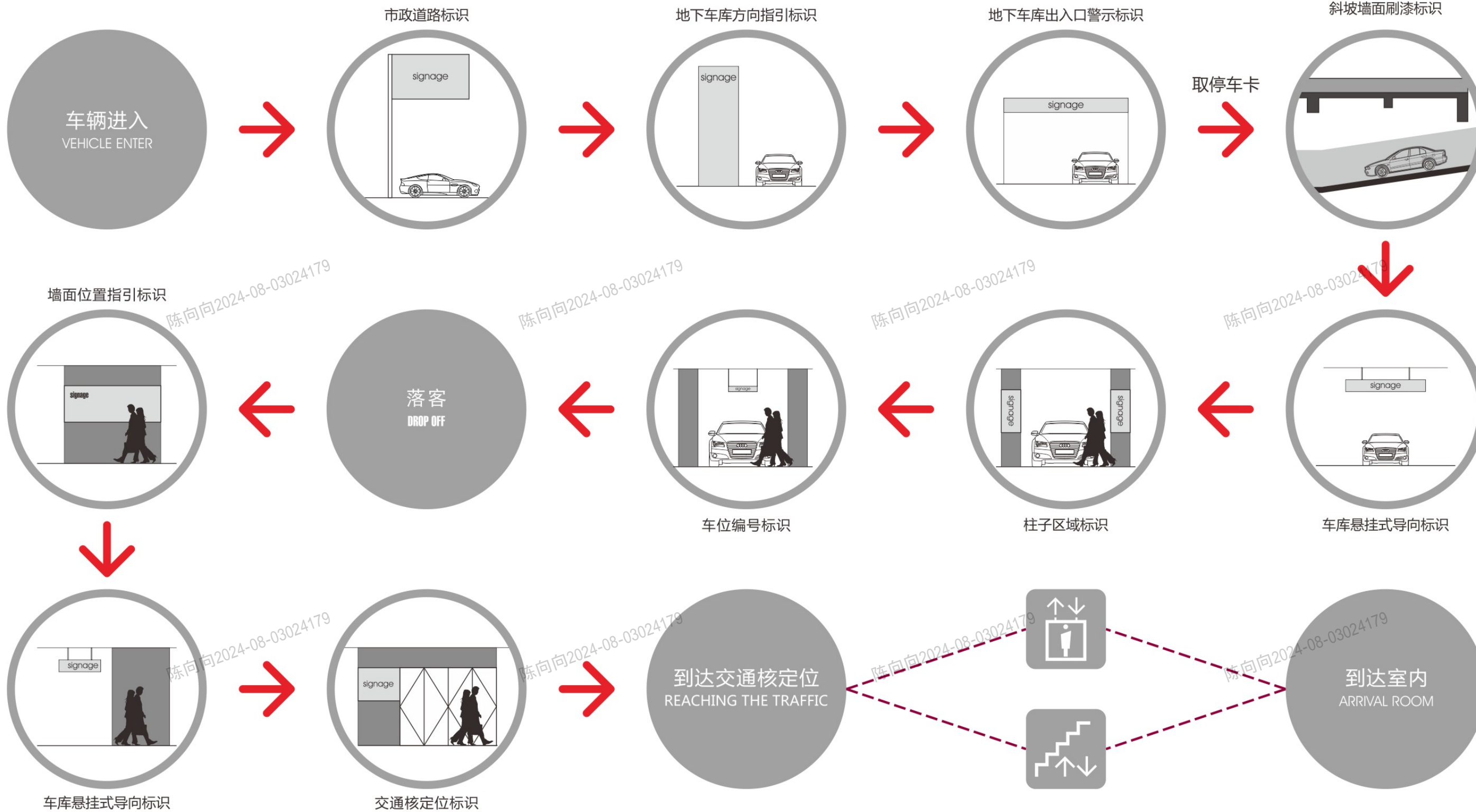

# 地库引导离去流程

PARKING GUIDANCE  
TO LEAVE PROCESS

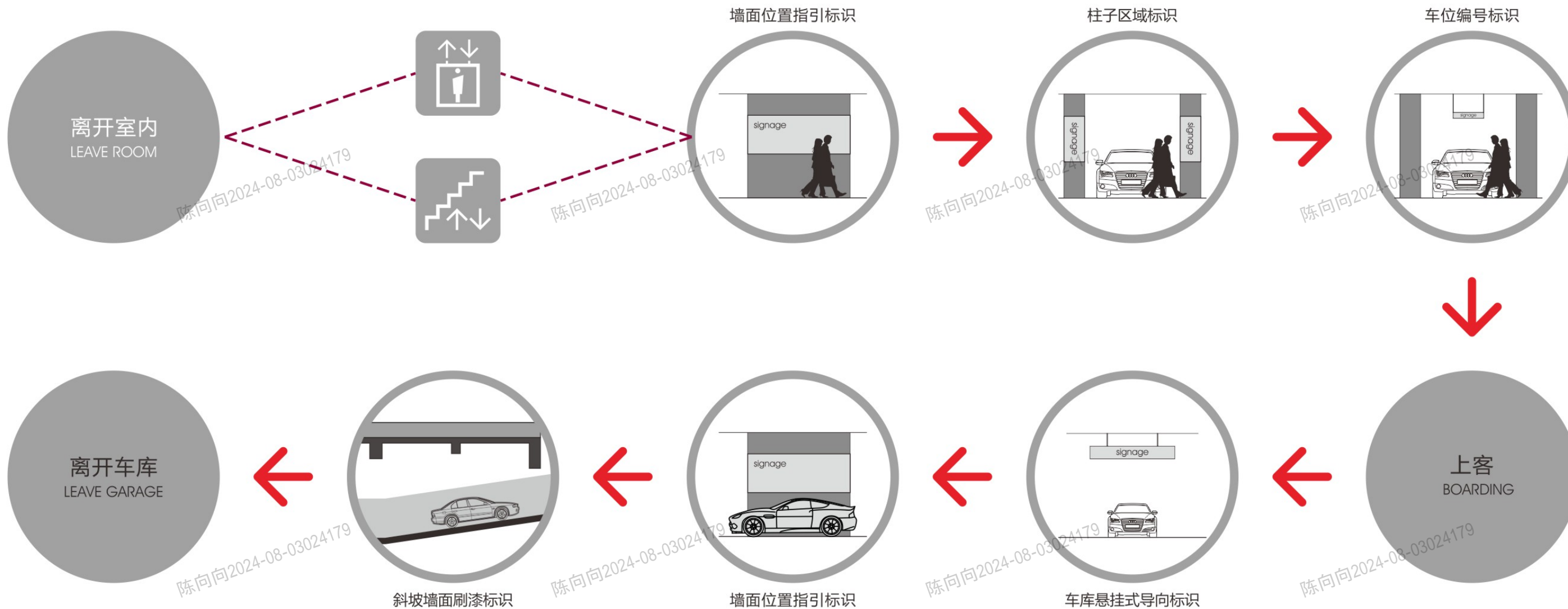

UNDERGROUND GARAGE CAR ACTION LINE ANALYSIS

地下车库-负一层 车行动线分析

- 7.1.1 车行指引吊牌 数量:18个
- 7.2.1 单元入口吊牌 数量:26个

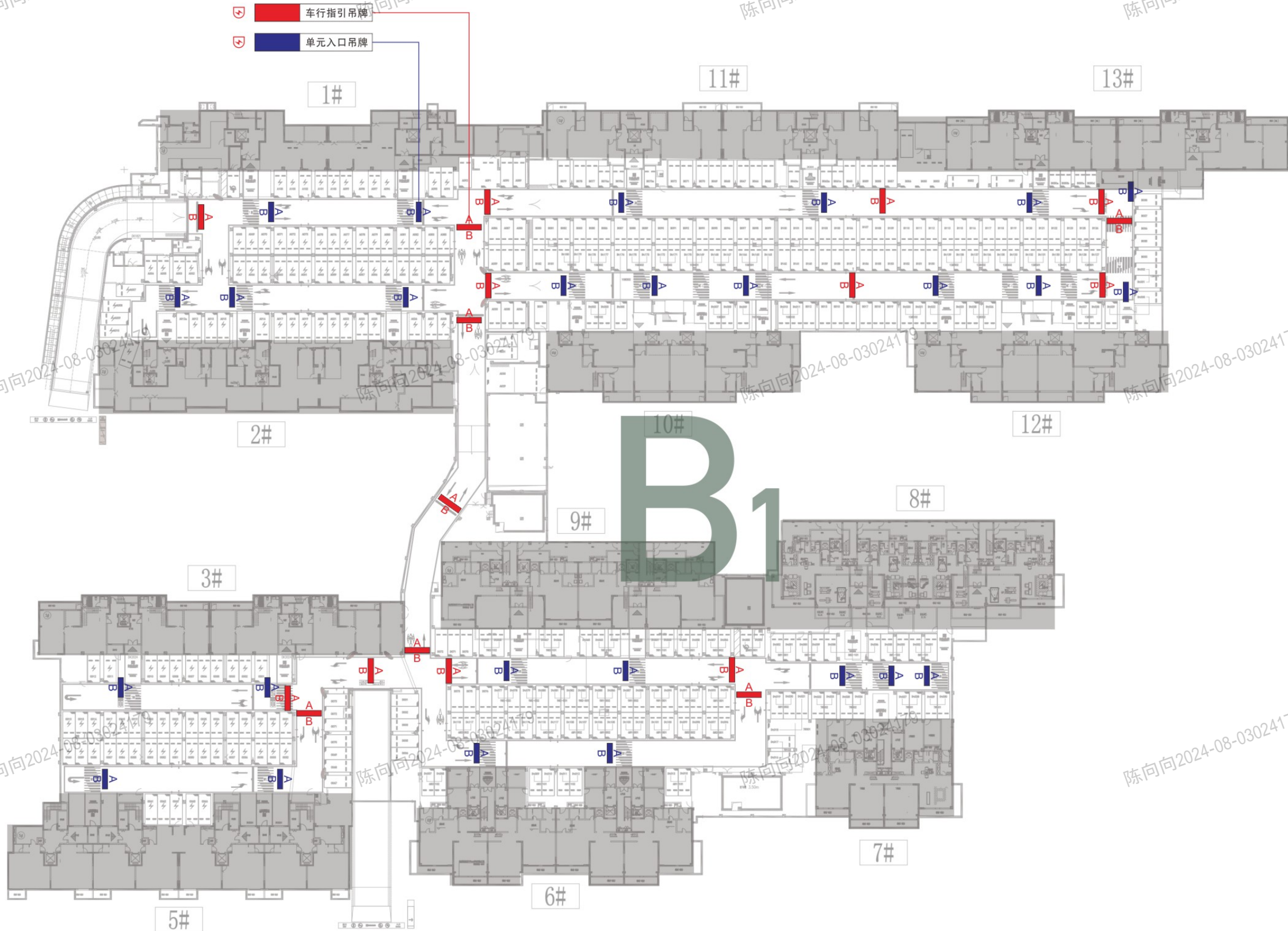

备注 NOTES:

THE COPYRIGHT OF THIS DRAWING IS OWNED BY HENAN VIENTIANE SIGN DESIGN CO., LTD. 此图纸版权为河南万象标识设计有限公司所有

ALL LOCATION / SETTING OUT TO BE CONFIRMED ON SITE BY CLIENT/DESIGN DESIGN CONSULTANT/CONTRACTOR 所有标志位置/标志尺寸图须由客户/设计顾问/项目承建商现场确认

图例 LEGEND



- Ground reserved power supply 地面预留电源
- Reserved wall power supply 墙面预留电源
- Reserved power supply for ceiling 吊顶预留电源

备注NOTES:

THE COPYRIGHT OF THIS DRAWING IS OWNED BY HENAN VIENTIANE SIGN DESIGN CO., LTD. 此图纸版权为河南万象标识设计有限公司所有

DESIGN INTENT ONLY CONTRACTOR TO SUBMIT SHOP DRAWING FOR APPROVAL 此图仅为施工指导图, 承建商须提交施工详图与有关单位核校

ALL LOCATION / SETTING OUT TO BE CONFIRMED ON SITE BY CONTRACTOR 所有标志位置/标志尺寸图须由客户/设计顾问/项目承建商现场确认

ALL MEASUREMENTS ARE TO BE CONFIRMED ON SITE BY CONTRACTOR 所有标志尺寸应由项目承建商现场确认

ALL QUANTITY TO BE VERIFIED BY CLIENT/QUANTITY SURVEYOR 所有标志数量须经客户确认

CONTRACTOR TO SUBMIT WATERPROOFING DETAIL. CONTRACTOR RESPONSIBLE FOR STRUCTURAL CALCULATION. 项目承建商负责提交防水细节, 项目承建商负责有关结构计算

郑州市金水区北三环73号瀚海北金商务楼B座19A层  
19A floor, block B, Hanhai Beijing business building, 73 North Third Ring Road, Jinshui District, Zhengzhou  
www.hnwxbs.cn

T/F 0371-8606 0306  
18337166686  
13949057575  
18839776686

PROJECT TITLE 项目

CLIENT TITLE 客户

INFORMATION 设计说明

SCALE 图示

APPROVE 审定

CHECK 审核

CHARGE 负责人

DRAWING 制图

DATE 日期

DRAWING NO.

# 7.1.1

## INTERIOR SIGN DESIGN

车行指引吊牌  
数量:共18个



示意图-SKETCH MAP

### 备注NOTES:

THE COPYRIGHT OF THIS DRAWING IS OWNED BY HENAN VIENTIANE SIGN DESIGN CO., LTD. 此图纸版权为河南万象标识设计有限公司所有。DESIGN INTENT ONLY CONTRACTOR TO SUBMIT SHOP-DRAWING FOR APPROVAL. 此图仅为施工指导图, 承包商须提交施工明细图与有关单位复核。  
ALL LOCATION / SETTING OUT TO BE CONFIRMED ON SITE BY CLIENT/DESIGN DESIGN CONSULTANT/CONTRACTOR. 所有标志位置/标志尺寸图须由客户/设计师/项目承包商现场复核确认。  
ALL MEASUREMENTS ARE TO BE CONFIRMED ON SITE BY CONTRACTOR. 所有标志尺寸应由项目承包商现场复核确认。  
ALL QUANTITY TO BE VERIFIED BY CLIENT/QUANTITY SURVEYOR. 所有标志数量须经客户确认。  
CONTRACTOR TO SUBMIT WATERPROOFING DETAIL. 项目承包商负责提交防水细节。  
CONTRACTOR RESPONSIBLE FOR STRUCTURAL CALCULATION. 项目承包商负责有关结构计算。



郑州市金水区北三环73号瀚海北金商务楼B座19A层  
19A floor, block B, Hanhai Beijin business building, 73 North Third Ring Road, Jinshui District, Zhengzhou  
www.hnwxbs.cn

T/F 0371-8606 0306  
18337166686  
13949057575  
18839776686

PROJECT TITLE 项目

CLIENT TITLE 客户

INFORMATION 设计说明

SCALE 图示

APPROVE 审定

CHECK 审核

CHARGE 负责人

DRAWING 制图

DATE 日期

DRAWING NO.



### 安装示意

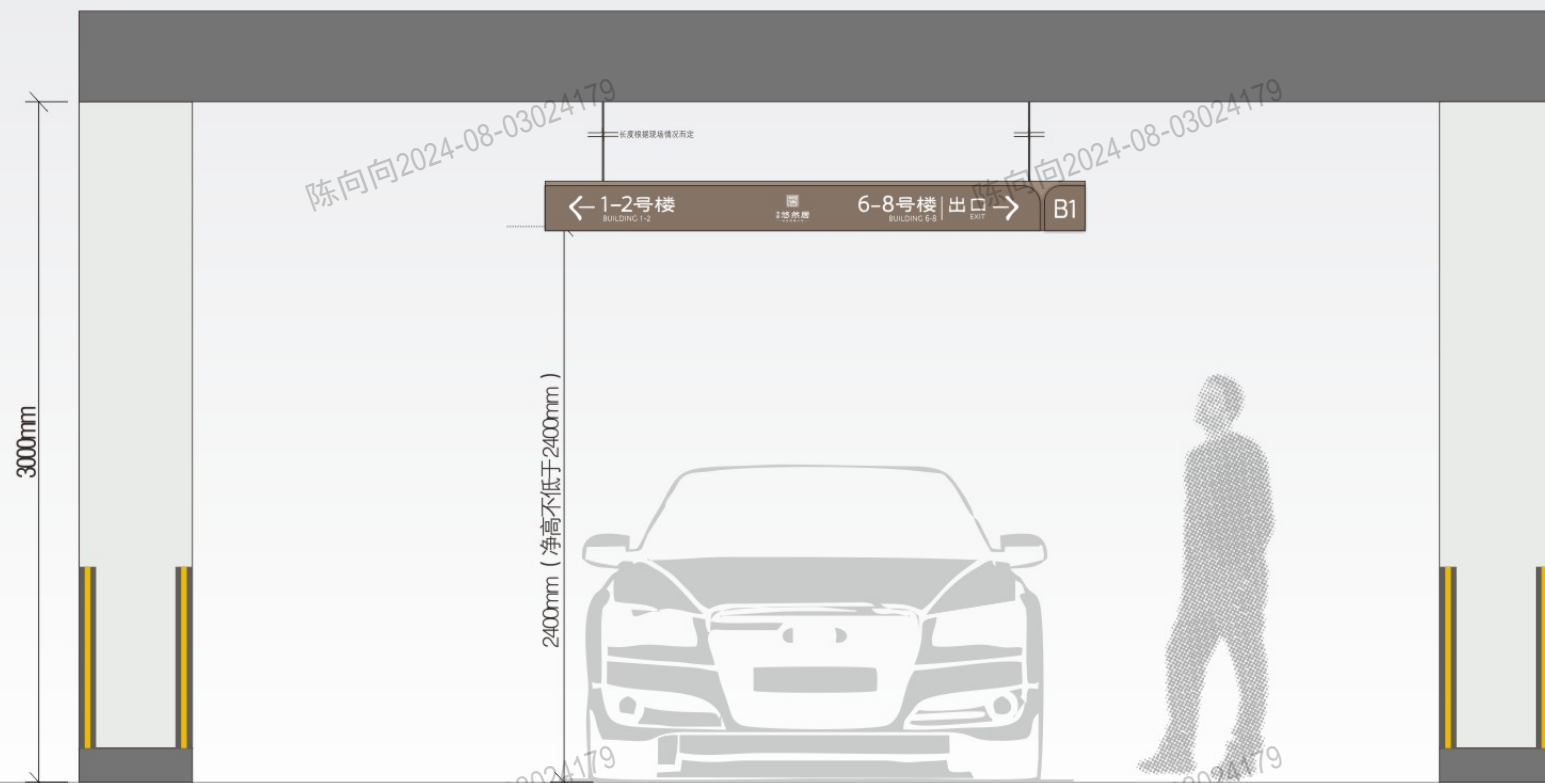

# 7.2.1

## INDOOR SIGN PARTS

单元入口标识  
数量:共26个



示意图-SKETCH MAP

### 备注NOTES:

THE COPYRIGHT OF THIS DRAWING IS OWNED BY HENAN VIENTIANE SIGN DESIGN CO., LTD. 此图版权归河南万象标识设计有限公司所有。DESIGN INTENT ONLY CONTRACTOR TO SUBMIT SHOP-DRAWING FOR APPROVAL. 此图仅为施工指导图, 承包商须提交施工明细图与有关单位复核。

ALL LOCATION / SETTING OUT TO BE CONFIRMED ON SITE BY CLIENT/DESIGN DESIGN CONSULTANT/CONTRACTOR. 所有标志位置/标志尺寸须由客户/设计师/项目承包商现场复核确认。

ALL MEASUREMENTS ARE TO BE CONFIRMED ON SITE BY CONTRACTOR. 所有标志尺寸应由项目承包商现场复核确认。

ALL QUANTITY TO BE VERIFIED BY CLIENT/QUANTITY SURVEYOR. 所有标志数量须经客户确认。

CONTRACTOR TO SUBMIT WATERPROOFING DETAIL. 项目承包商负责提交防水细节。

CONTRACTOR RESPONSIBLE FOR STRUCTURAL CALCULATION. 项目承包商负责有关结构计算。



郑州市金水区北三环73号瀚海北金商务楼B座19A层  
19A floor, block B, Hanhai Beijing business building, 73 North Third Ring Road, Jinshui District, Zhengzhou  
www.hnwxbs.cn

T/F 0371-8606 0306  
18337166686  
13949057575  
18839776686

PROJECT TITLE 项目

CLIENT TITLE 客户

INFORMATION 设计说明

SCALE 图示

APPROVE 审定

CHECK 审核

CHARGE 负责人

DRAWING 制图

DATE 日期

DRAWING NO.



1 立面 - Elevation  
1:10

φ 15mm 201# 不锈钢圆管激光切割  
焊接成型, 汽车烤金属漆

1.2mm 厚 201 拉丝不锈钢板激光切割  
焊接成型, 汽车烤金属漆

镂空, 内衬乳白亚克力,  
内置 LED 白色光源

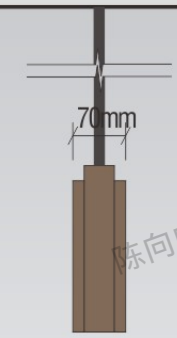

2 侧立面 - Side Elevation  
1:10

### 安装示意

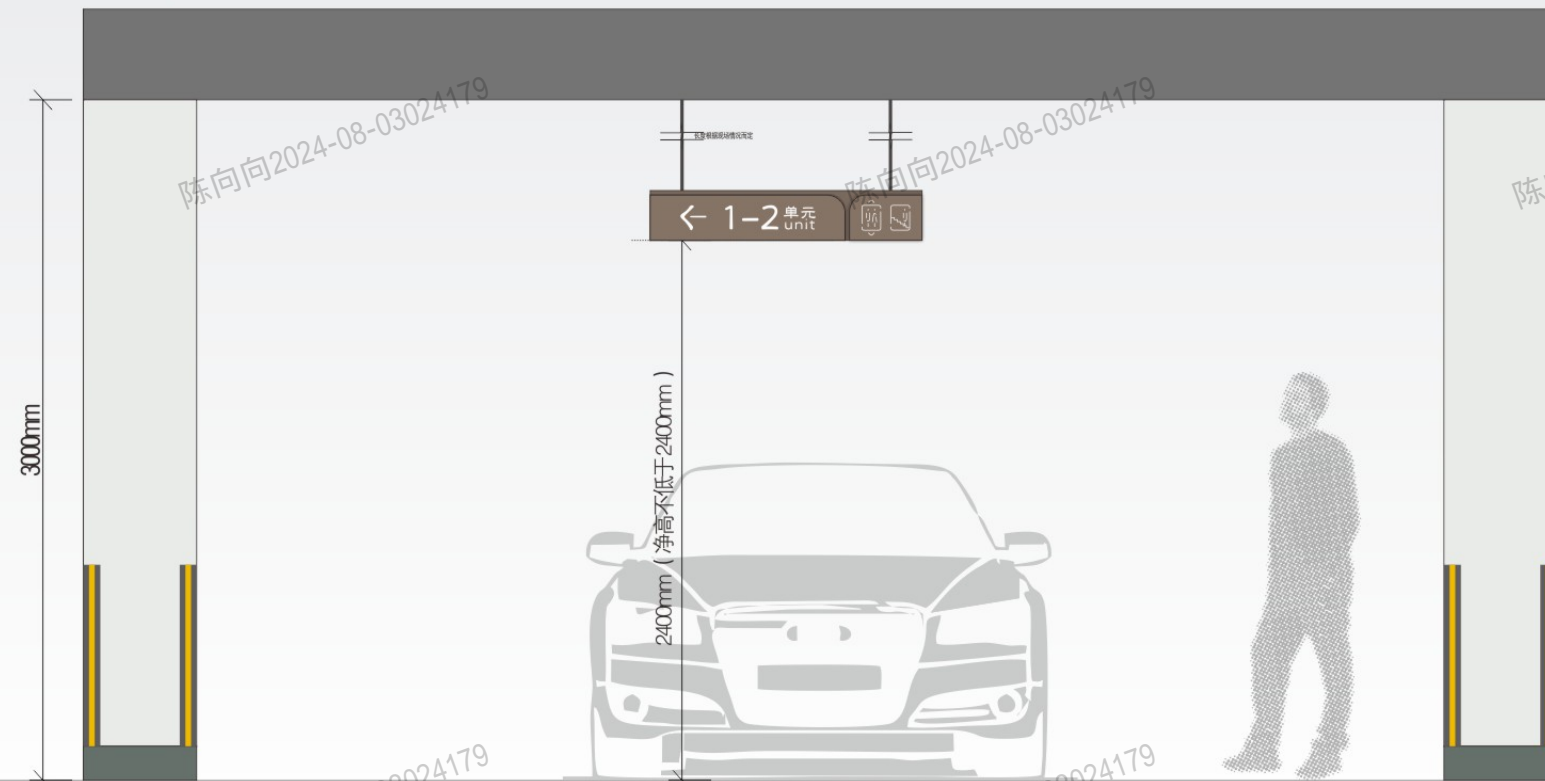

# 7.3.1

## INDOOR SIGN PARTS

私家车位标识吊牌  
数量:400个

### 备注NOTES:

THE COPYRIGHT OF THIS DRAWING IS OWNED BY HENAN VIENTIANE SIGN DESIGN CO., LTD. 此图版权归河南万象标识设计有限公司所有。DESIGN INTENT ONLY CONTRACTOR TO SUBMIT SHOP-DRAWING FOR APPROVAL. 此图仅为施工指导图，承包商提交施工明细图与有关单位复核。

ALL LOCATION / SETTING OUT TO BE CONFIRMED ON SITE BY CLIENT/DESIGNER/CONTRACTOR. 所有标志位置/标志尺寸应由客户/设计师/项目承包商现场复核确认。

ALL MEASUREMENTS ARE TO BE CONFIRMED ON SITE BY CONTRACTOR. 所有标志尺寸应由项目承包商现场复核确认。

ALL QUANTITY TO BE VERIFIED BY CLIENT/QUANTITY SURVEYOR. 所有标志数量须经客户确认。

CONTRACTOR TO SUBMIT WATERPROOFING DETAIL. 项目承包商负责提交防水细节。

CONTRACTOR RESPONSIBLE FOR STRUCTURAL CALCULATION. 项目承包商应负责有关结构计算。



郑州市金水区北三环73号瀚海北金商务楼B座19A层  
19A floor, block B, Hanhai Beijing business building, 73 North Third Ring Road, Jinshui District, Zhengzhou  
www.hnwxbs.cn

T/F 0371-8606 0306  
18337166686  
13949057575  
18839776686

PROJECT TITLE 项目

CLIENT TITLE 客户

INFORMATION 设计说明

SCALE 图示

APPROVE 审定

CHECK 审核

CHARGE 负责人

DRAWING 制图

DATE 日期

DRAWING NO.

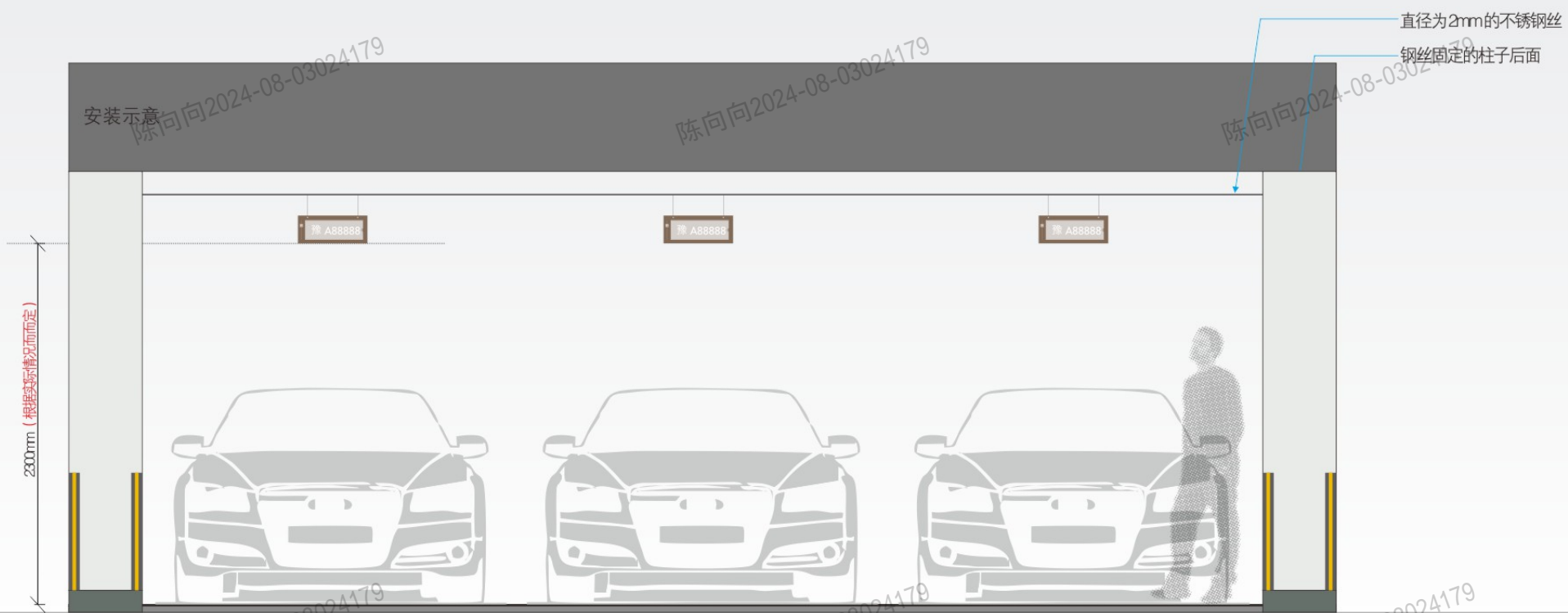
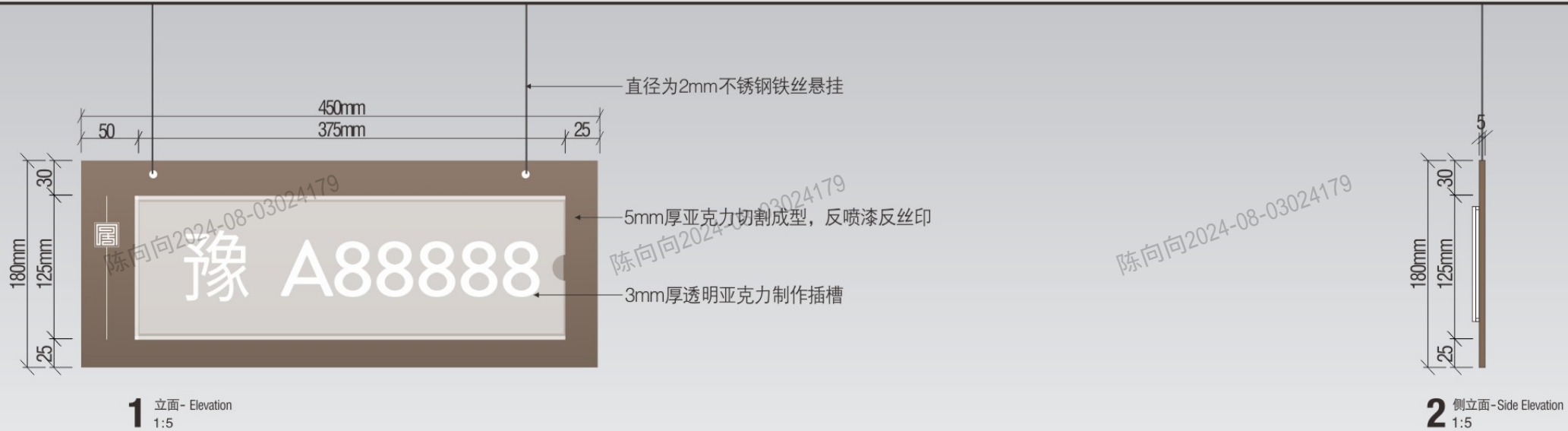

# 7.4.1

## INDOOR SIGN PARTS

地库充电须知  
数量:1个

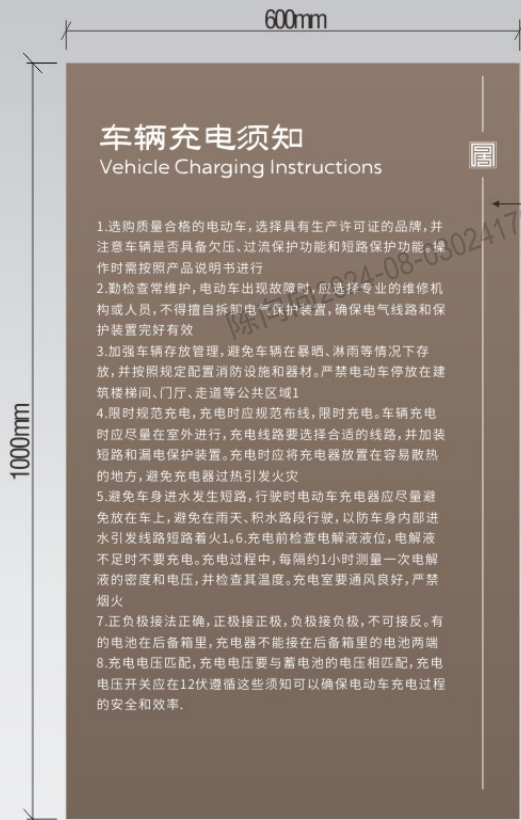

1 立面 - Elevation  
1:10

5mm厚亚克力切割成型, 反喷漆反丝印

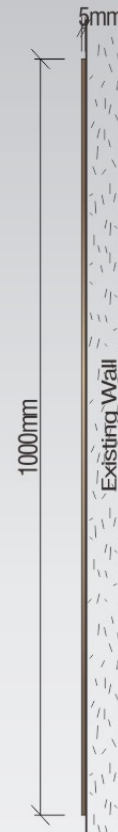

2 侧立面 - Side Elevation  
1:10

### 备注NOTES:

THE COPYRIGHT OF THIS DRAWING IS OWNED BY HENAN VIENTIANE SIGN DESIGN CO., LTD. 此图版权归为河南万象标识设计有限公司所有。DESIGN INTENT ONLY CONTRACTOR TO SUBMIT SHOP-DRAWING FOR APPROVAL. 此图仅为施工指导图, 承包商须提交施工详图与有关单位核校。

ALL LOCATION / SETTING OUT TO BE CONFIRMED ON SITE BY CLIENT/DESIGNER/DESIGN CONSULTANT/CONTRACTOR. 所有标志位置/标志尺寸由客户/设计师/项目承建商现场复核确认。

ALL MEASUREMENTS ARE TO BE CONFIRMED ON SITE BY CONTRACTOR. 所有标志尺寸应由项目承建商现场复核确认。

ALL QUANTITY TO BE VERIFIED BY CLIENT/QUANTITY SURVEYOR. 所有标志数量须经客户确认。

CONTRACTOR TO SUBMIT WATERPROOFING DETAIL. 项目承建商负责提交防水细节。

CONTRACTOR RESPONSIBLE FOR STRUCTURAL CALCULATION. 项目承建商负责有关结构计算。



郑州市金水区北三环73号瀚海北金商务楼B座19A层  
19A floor, block B, Hanhai Beijing business building, 73 North Third Ring Road, Jinshui District, Zhengzhou  
www.hnwxbs.cn

T/F 0371-8606 0306  
18337166686  
13949057575  
18839776686

PROJECT TITLE 项目

CLIENT TITLE 客户

INFORMATION 设计说明

SCALE 图例

APPROVE 审定

CHECK 审核

CHARGE 负责人

DRAWING 制图

DATE 日期

DRAWING NO.

08-03024179

陈向向2024-08-03024179

陈向向2024-08-03024179

陈向向2024-08-03024179

陈向向2024-08-03024179

# Thanks!



郑州市金水区北三环73号瀚海北金商务楼B座19A层  
19A floor, block B, Hanhai Beijin business building, 73 North Third Ring Road, Jinshui District, Zhengzhou  
www.hnwxbs.cn  
T/F 0371-8606 0306  
18337166686  
13949057575  
18839776686

08-03024179

陈向向2024-08-03024179

陈向向2024-08-03024179

陈向向2024-08-03024179

陈向向2024-08-03024179

08-03024179

陈向向2024-08-03024179

陈向向2024-08-03024179

陈向向2024-08-03024179

陈向向2024-08-03024179

08-03024179

08-03024179

08-03024179

08-03024179

08-03024179